

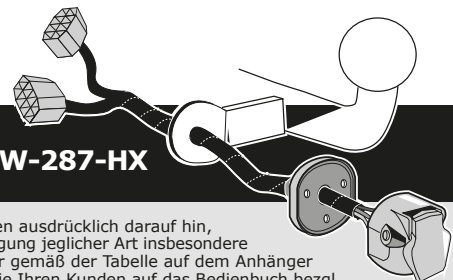

Volkswagen ID.3 (E11, E12) 08/2023 >>
Volkswagen ID.4 (E21) 08/2023 >>
Volkswagen ID.5 (E39) 08/2023 >>
Skoda Enyaq iV 08/2023 >>
Skoda Enyaq Coupe iV 08/2023 >>



**For models with and without trailer preparation
Für Fahrzeuge mit und ohne Anhängervorbereitung**

Partnr.: VW-287-HX

- DE** • Einbauanleitung Elektrosatz Anhängervorrichtung mit 13-P Steckdose lt. DIN/ISO Norm 11446. • Wir weisen ausdrücklich darauf hin, dass eine unsachgemäße und nicht in einer Fachwerkstatt durchgeführte Montage einen Verzicht auf Entschädigung jeglicher Art insbesondere bezüglich des Produkthaftpflichtrechts zur Folge hat. • Technische Änderungen vorbehalten. • Widerstand nur gemäß der Tabelle auf dem Anhänger verwenden. • Achtung! Bitte lesen Sie vorab diese Anleitung, nehmen Sie diese zur Kenntnis und verweisen Sie Ihren Kunden auf das Bedienbuch bezgl. der eventuell zu treffenden Maßnahmen zum Ziehen eines Anhängers. • Bei Funktionsproblemen ist die Fehlersuche auf ca. 0,5 Stunden zu begrenzen, kontaktieren Sie die ECS Helpline: ts@ecs-electronics.nl / 00800 22552327
- FR** • Instructions de montage du faisceau électrique pour crochet d'attelage conforme à la norme DIN/ISO 11446 prise 13-P. • Il est expressément prévu qu' on ne saurait se prévaloir d'un quelconque préjudice contractuel ou réhibitoire si le montage avait été fait en dépit des dites instructions ou dans un garage ne disposant pas des équipements adéquats. • Sous réserve de modifications techniques. • Ne excédez pas la charge maximale, indiquée dans le tableau. • Attention! Avant de commencer le branchement, on vous prie de prendre compte des connections à faire dans la notice, ainsi que communiquer directement à votre client les mesures à prendre pour tirer une remorque. • S'il y a des problèmes de fonctionnement, limiter la recherche de défauts à env. 30 minutes et contacter ECS l'Aide en ligne: ts@ecs-electronics.nl / 00800 22 55 23 27.
- NL** • Montage-handleiding elektrokabelset voor trekhaak met 13-P contactdoos vlg. DIN/ISO norm 11446. • Wij wijzen er met nadruk op, dat ondeskundige en niet door een vakkundige werkplaats uitgevoerde montage tot gevolg heeft dat daardoor ieder recht op schadevergoeding, ook op wettelijke aansprakelijkheid inzake producten, vervalt. • Technische wijzigingen voorbehouden. • Gebruik alleen belasting volgens aansluittabel op het getrokken voertuig. • Opgelet! Wij verzoeken U dringend vooraf deze instructie door te nemen, hiervan kennis te nemen en uw cliënt te verwijzen naar het instructieboekje betreffende de eventueel te nemen maatregelen voor het trekken van een aanhangwagen. • Bij werkingsproblemen moet de foutencontrole tot ca. 0,5 uur beperkt worden, neem contact op met de ECS Helpline: ts@ecs-electronics.nl / 00800 22 55 23 27.
- GB** • Fitting instructions electric wiring kit tow bar with 13-P socket up to DIN/ISO Norm 11446. • We would expressly point out that assembly not carried out properly by a competent installer will result in cancellation of any right to damage compensation, in particular those arising by virtue of the product liability act. • Contents of these kits and their fitting manuals are subject to alteration without notice, please ensure that these instructions are read and fully understood before commencing installation. • Do not overload circuits; the maximum loads per connection are detailed in this manual. • Attention! Before Installation, please read this manual carefully and inform your customer to consult the vehicle owners manual to check for any vehicle modifications required before towing. • In the event of functional problems, troubleshooting must be limited to about 0.5 hours, contact the ECS Helpline: ts@ecs-electronics.nl / 00800 22 55 23 27.
- ES** • Instrucciones de montaje de kit eléctrico para enganche de remolque con caja de conexiones 13-P según norma DIN/ISO 11446. • El montaje inapropiado y efectuado por personal no cualificado originará la pérdida de todo derecho a indemnización o la expiración de toda responsabilidad civil con respecto al producto. • Nos reservamos el derecho a efectuar modificaciones técnicas. • Utilice sólo cargas de acuerdo a la tabla de conexión del vehículo remolcado. • Atención: lea atentamente este manual antes de la instalación e informe al cliente que debe consultar el manual de usuario del vehículo para conocer cualquier modificación realizada. • En caso de tener problemas con su funcionamiento, la búsqueda de errores está limitada a aprox. 0,5 horas, por lo que le recomendamos ponerse en contacto con el servicio de atención telefónica: ts@ecs-electronics.nl / 00800 22 55 23 27.
- IT** • Istruzioni di montaggio di set di cavi elettrici per gancio da traino con zoccolo a 13-P conforme alla norma DIN/ISO 11446. • Sottolineiamo espressamente che un montaggio inadeguato ed eseguito da un'officina non specializzata ha come conseguenza il decadere di qualsiasi diritto al risarcimento danni, nonché alla responsabilità legale relativa ai prodotti. • Ci si riserva il diritto di apportare modifiche tecniche. • Utilizzare esclusivamente un carico conforme alla tabella degli allacci relativa al veicolo in questione. • Attenzione! Vi invitiamo a leggere attentamente questo manuale e a invitare a vostra volta i clienti a leggere il manuale del conducente sulle eventuali misure da prendere per l'attacco di un rimorchio. • In caso di problemi di funzionamento, la ricerca di errori dovrebbe essere limitata a circa 0,5 ore. Contattare il centralino di assistenza per i fasci di cavi: ts@ecs-electronics.nl / 00800 22 55 23 27.
- SE** • Monteringsanvisningar elkabelsats för dragkrok med 13-P kontaktdosa enligt DIN/ISO norm 11446. • Vi påpekar med eftertryck att all rätt till skadeersättning och all laglig ansvarighet förfaller om monteringen inte har utförts på rätt sätt och av en professionell verkstad. • Tekniska ändringar förbehålles. • Använd endast belastning enligt anslutningstabellen på det dragna fordonet. • Varning! Innan installation, läs den här handboken noga och informera din kund om att läsa fordonets användarhandbok för att undersöka vilka eventuella ändringar som behöver göras på fordonet. • Vid funtionsproblem ska felsökningen begränsas till ca 0,5 timme, kontakta reservdels-helpline ts@ecs-electronics.nl / 00800 22 55 23 27.
- CZ** • Montážní pokyny: souprava pro elektrické propojení tažné tyče s 13-P zásuvkou do normy DIN/ISO 11446. • Výslovně zdůrazňujeme, že jakákoli montáž, která není provedená ve specializované dílně, má za následek odvolání nároků na kompenzaci jakéhokoli druhu, obzvláště vyplývajících ze zákona o odpovědnosti za způsobené škody. • Změny mohou být provedeny bez oznámení. • Používejte pouze při maximálním nabití podle tabulky na tažném vozidle. • Upozornění! Prosíme, abyste si nejdříve přečetli tyto instrukce, seznámili se s nimi a odkázali své zákazníky na příručku týkající se případných opatření, která musí být přijata pro tažení přívěsu. • Při problémech funkčnosti je třeba vyhledávání chyb omezit na cca 0,5 hodiny, kontaktujte ECS Helpline: ts@ecs-electronics.nl / 00800 22 55 23 27.
- DK** • Monteringsvejledninger for det elektriske ledningsføringssæt for trækstang med 13-P stikdåse, DIN/ISO, norm 11446. • Vi ønsker at gøre udtrykkeligt opmærksom på atfærket samling, der ikke er udført af et specialiseret værksted, resulterer i bortfaldelse af kompensationskrav af alle slags, i særdeleshed krav der måtte opstå omkring det lovlige ansvar. • Kan ændres uden varsel. • Brug kun den maksimale belastning, i overensstemmelse med forbindelsestabelen for bugserede køretøjer. • OBS! For installation skal denne vejledning læses omhyggeligt og din kunde skal informeres om at kigge i køretøjets håndbog for at kontrollere om der skal laves eventuelle ændringer på køretøjet inden bugsering. • Ved funktionsproblemer skal fejlsøgningen begrænses til ca. 0,5 time, kontakt ECS Helpline: ts@ecs-electronics.nl / 00800 22 55 23 27.
- FI** • Ohjeet vetokoukun sähkökaapelisarjan asentamiseen, jossa on DIN/ISO 11446 mukainen 13-P liitin. • Korostamme, että kaikki oikeudet vahinkokorvaukseen kuten myös valmistajan laillinen vastuu raukeavat, mikäli asennusta ei ole toteutettu oikealla tavalla eikä ammattitaitoisen asiantuntijan toimesta. • Oikeus teknisiin muutoksiin ilman erillistä huomautusta pidätetään. • Huomio! Lue tämä käyttöoppas huolellisesti ennen asennusta ja tiedota asiakkaita tarkistamaan kaikki ajoneuvon muutoksen ajoneuvon omistajan käyttöoppaas ennen hinausta. • Kuormita työvirtapiiriä ainoastaan hinattavan ajoneuvon kytkentäkaavan mukaisesti. • Virhehaku on rajoitettava toiminto-ongelmien esiintyessä noin 0,5 tuntiin, ota yhteys ECS Helpline: ts@ecs-electronics.nl / 00800 22 55 23 27.
- GR** • Οδηγίες συναρμολόγησης ηλεκτρικού σετ καλωδίων μπάρας ρυμούλκησης με υποδοχή 13-P μέχρι DIN/ISO Κανόνας 11446. • Επισημαίνουμε κατηγορηματικά ότι οποιαδήποτε εσφαλμένη συναρμολόγηση, η οποία δεν έχει πραγματοποιηθεί ειδικό εργαστήριο θα οδηγήσει σε αποποίηση των αξιώσεων επιβολής αποζημιώσεων οποιοδήποτε είδους, ειδικά όσα προκύπτουν από το νόμο ευθύνης προϊόντων. • Μπορεί να τροποποιηθεί χωρίς προηγούμενη ειδοποίηση. • Χρησιμοποιείτε μόνο μέγιστο ηλεκτρικό φορτίο σύμφωνα με τον πίνακα σύνδεσης στο ρυμούλκούμενο όχημα. • Προσοχή! Πριν την εγκατάσταση, διαβάστε το εγχειρίδιο αυτό προσεκτικά και ενημερώστε τον πελάτη σας να συμβουλευτεί το εγχειρίδιο ιδιοκτητήτων οχήματος ώστε να ελέγξει τυχόν τροποποιήσεις που απαιτούνται στο όχημα πριν τη ρυμούλκηση. • Σε περίπτωση προβλημάτων λειτουργίας να περιοριστεί η αναζήτηση σφαλμάτων σε περί. 0,5 δευτ., επικοινωνήστε με τη γραμμή υποστήριξης ECS Helpline: ts@ecs-electronics.nl / 00800 22 55 23 27.
- NO** • Monteringsanviser elkabelsett for trekkrok med 13-P koblingsboks ifølge DIN/ISO norm 11446. • Vi påpeker ettertrykkelig at all rett til skadeerstatning og rettslig ansvar forfaller dersom monteringen ikke er blitt utført på riktig måte og av et profesjonelt verksted. • Tekniske endringer forbeholdes. • Overskrid ikke grensene anviset i tilkoblingstabellen på tilhengeren eller det tilkoblede kjøretøyet. • OBS! Les denne bruksanvisningen nøye før installasjon. Be kunden om å rådføre seg med brukerhåndboken for kjøretøyeiere for å sjekke om kjøretøyet må modifiseres før tauing. • Ved funksjonsproblemer må feilsøket begrenses til ca. 0,5 timer, kontakt ECS Helpline: ts@ecs-electronics.nl / 00800 22 55 23 27.
- PL** • Instrukcje montażu zestawu okablowania elektrycznego dysza holowniczego z 13-P stykowym gniazdem DIN/ISO 11446. • Chcielibyśmy wyraźnie zaznaczyć, iż wszelki nieprawidłowy montaż, który nie jest wykonywany w specjalistycznym warsztacie pociąga za sobą utratę możliwości dochodzenia wszelkiego typu roszczeń, w szczególności tych wynikających z odpowiedzialności producenta za swój produkt. • Podlega zmianom bez powiadomienia. • Używać tylko takiego maksymalnego obciążenia które wynika z tabliczki połączeń holowanego pojazdu. • Uwaga! Przed zainstalowaniem należy dokładnie przeczytać tę instrukcję i poinformować klienta o konieczności sprawdzenia w instrukcji posiadacza pojazdu w celu sprawdzenia przed holowaniem, czy nie wprowadzono do pojazdu jakichkolwiek zmian. • W przypadku problemów ograniczyć wyszukiwanie błędów do ok. 0,5 godziny, skontaktować się z linią serwisową ts@ecs-electronics.nl / 00800 22 55 23 27.

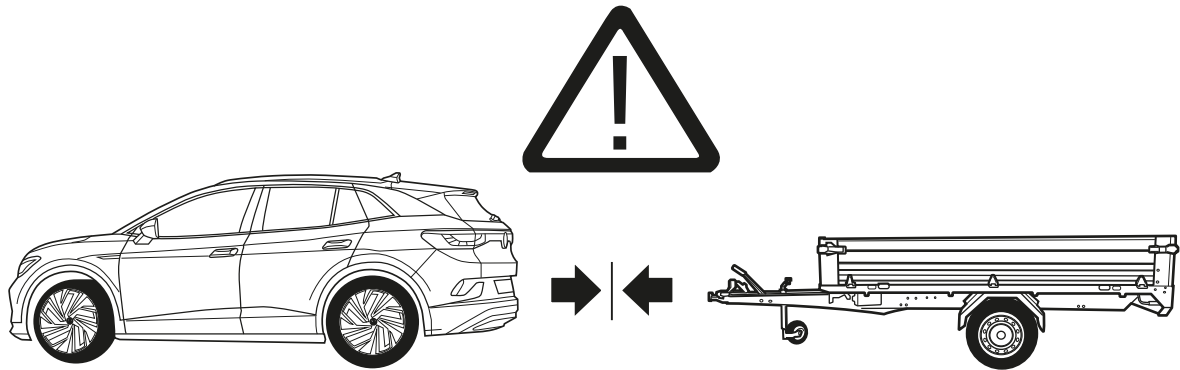

Dieser E-Satz unterstützt keine fahrzeugseitigen Assistenzsysteme.
Im Anhängerbetrieb müssen Assistenzsysteme gegebenenfalls manuell deaktiviert werden!

This kit does not support any of the assistance systems of the vehicle.
Vehicle assistance systems may have to be deactivated manually when towing a trailer!

Deze set ondersteunt geen van de assistentiesystemen van het voertuig of schakelt deze niet uit.

Ce faisceau d'attelage ne prend pas en charge et ne désactive aucun des systèmes d'assistance du véhicule.

Este kit no es compatible ni desactiva los sistemas de asistencia del vehículo.

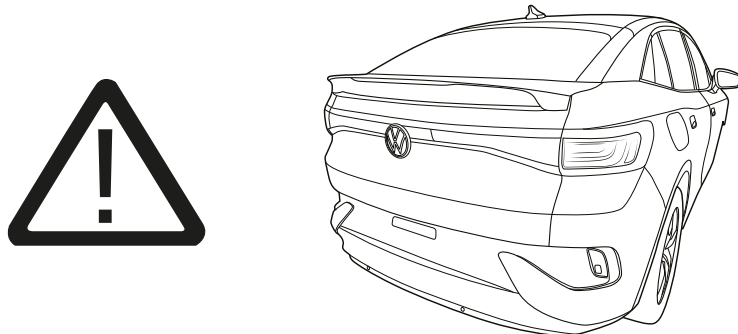

Bitte beachten Sie, dass die Bedienung der elektrischen Heckklappe auch bei angeschlossenem Fahrradträger/Anhänger/Wohnwagen weiterhin funktioniert. Sie muss manuell bedient werden.

Please note that the operation of the electric tailgate will continue to function with a bicycle carrier/trailer/caravan attached. It must be operated manually.

Houd er rekening mee dat de werking van de automatische elektrische achterklep zal blijven functioneren met een aangesloten fietsdrager/trailer/caravan. Deze moet handmatig worden bediend.

Veuillez noter que le fonctionnement du hayon électrique automatique continuera de fonctionner avec un porte-vélos/remorque/caravane connecté. Il doit être actionné manuellement.

Atención, apertura y cierre automático del maletero seguirá funcionando con un portabicicletas, remolque o caravana conectado. Estas funciones se deben de manejar manualmente.

Bitte beachten:

Im Anhängerbetrieb werden Assistenzsysteme mit Notbremsfunktion (AEB) weder beeinflusst noch automatisch deaktiviert.

DE

Automatische oder ferngesteuerte Einpark-Assistenzsysteme dürfen im Anhängerbetrieb nicht verwendet werden! Für weitere Informationen siehe Bedienungsanleitung Fahrzeug.

Please note:

Assistance systems with emergency brake function (AEB) will not be influenced or automatically deactivated whilst a trailer is attached.

GB

Automatic or remote-controlled parking assistance systems must not be used whilst a trailer is attached! For more information please refer to the vehicle owner's manual

Remarques:

Les systèmes d'assistance avec fonction de freinage d'urgence autonome (AEB) ne seront ni influencés, ni désactivés automatiquement lorsqu'une remorque est attelée.

FR

Les systèmes d'assistance au stationnement automatiques ou télécommandés ne doivent pas être utilisés lorsqu'une remorque est attelée !
Pour plus d'informations, reportez-vous au manuel d'instruction du véhicule.

Nota:

El sistema inteligente de frenado de emergencia autónoma (AEB) no se verá afectado ni se desactivará automáticamente mientras lleve un remolque acoplado.

ES

No se deben de utilizar el asistente de ayuda al estacionamiento automáticos y de salida de aparcamiento o controlados a distancia.
Para más información consulte el manual del vehículo.

Da notare:

I sistemi di assistenza con funzione freno di emergenza (AEB) non saranno influenzati o disattivati automaticamente mentre è montato un rimorchio.

IT

I sistemi di assistenza al parcheggio automatici o telecomandati non devono essere utilizzati mentre è montato un rimorchio!
Per ulteriori informazioni, consultare il manuale dell'utente del veicolo.

Let op:

Hulpsystemen met AEB functie (autonoom noodrem) worden niet automatisch beïnvloed of gedeactiveerd wanneer een aanhangwagen wordt aangekoppeld.

NL

Automatische of op afstand bediende parkeerhulpsystemen mogen niet worden gebruikt wanneer een aanhangwagen wordt gekoppeld!
Voor meer informatieve raadpleeg de instructie boekje van het voertuig.

Einzelteilliste

Liste de pieces

Onderdelenlijst

Part list

Lista de componentes

Elenco componenti

Dellista

Seznam dílů

Del-liste

Osaluettelo

Κατάλογος εξαρτημάτων

Dellista

Lista części

DE

FR

NL

GB

ES

IT

SE

CZ

DK

FI

GR

NO

PL

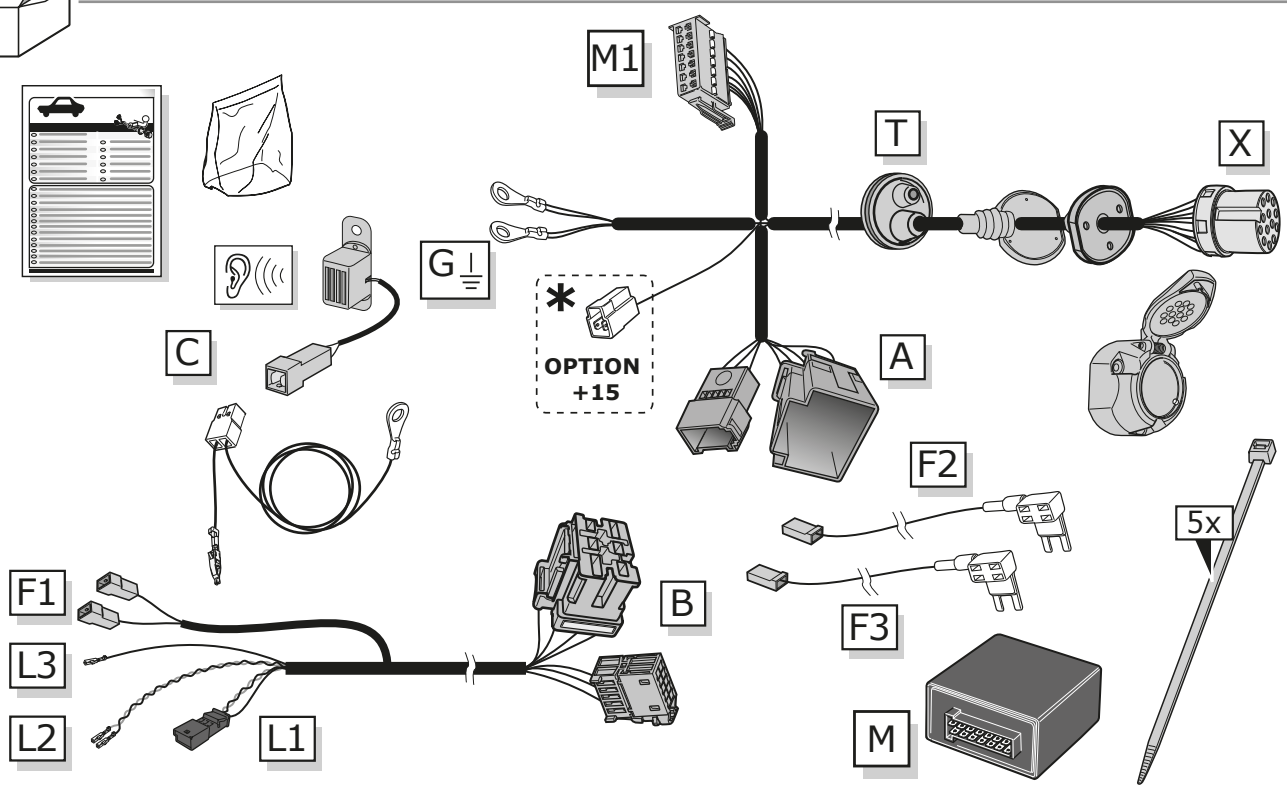
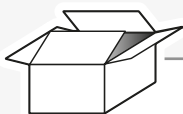

*** OPTION +15**

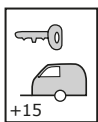

- DE Vorbereitung für +15
- FR Préparation pour +15
- NL Voorbereiding voor +15
- GB Preparation for +15
- ES Preparación para +15
- IT Preparazione per +15
- SE Förberedelse för +15
- CZ Příprava pro +15
- DK Forberedelse for +15
- FI Valmistelu varten +15
- GR Προετοιμασία για +15
- NO Forberedelse på +15
- PL Przygotowanie do +15

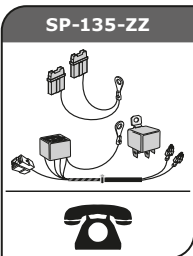

- DE Ergänzungsatz; fragen Sie Ihren Lieferanten.
- FR Set d'extension; consultez votre fournisseur
- NL Uitbreidingsset; raadpleeg uw leverancier
- GB Extension kit; consult your supplier
- ES Equipo de extensión; consulte con su proveedor
- IT Set di ampliamento; rivolgersi al proprio fornitore
- SE Förlängningsatts; be leverantören om råd
- CZ Prodlužovací souprava; poradte se s vaším dodavatelem
- DK Forlængelsesæt; henvend dig til din leverandør
- FI Lisäsarja; kysy neuvoa toimittajaltasi
- GR εξάρτηση επέκτασης; Συμβουλευθείτε τον προμηθευτή σας
- NO Påbyggingssett; forhør deg med din leverandør
- PL Zestaw rozszerzający; należy skonsultować się z dostawcą

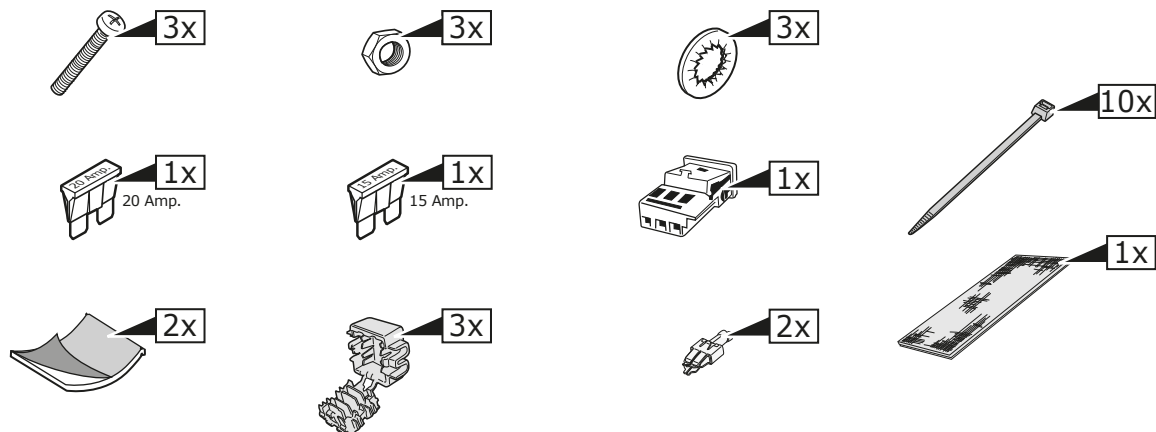

INFO

	BK	BN	BU	GY	GN	WH	YE	OG	PE	PI	RD	NL	BG	LG
DE	Schwarz	Braun	Blau	Grau	Grün	Weiß	Gelb	Orange	Violett	Rosa	Rot	Naturfarben	Beige	Hellgrün
FR	Noir	Marron	Bleu	Gris	Vert	Blanc	Jaune	Orange	Violet	Rose	Rouge	Nature	Beige	Vert Clair
NL	Zwart	Bruin	Blauw	Grijs	Groen	Wit	Geel	Oranje	Paars	Roze	Rood	Naturel	Beige	Licht Groen
GB	Black	Brown	Blue	Grey	Green	White	Yellow	Orange	Purple	Pink	Red	Natural colour	Beige	Light Green
ES	Negro	Marrón	Azul	Gris	Verde	Blanco	Amarillo	Naranja	Morado	Rosa	Rojo	Color natural	Beige	Verde Claro
IT	Nero	Marrone	Blu	Grigio	Verde	Bianco	Giallot	Arancione	Viola	Rosa	Rosso	Colori naturali	Beige	Verde Chiaro

ROUTING

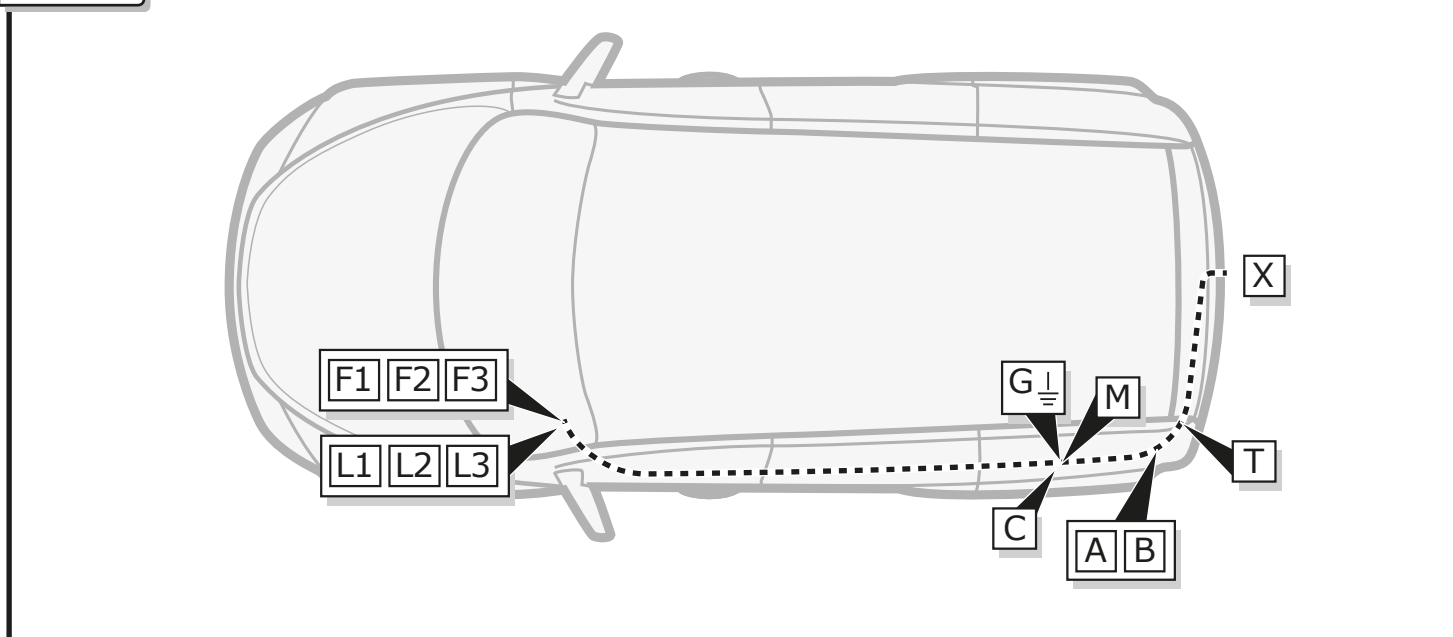

1

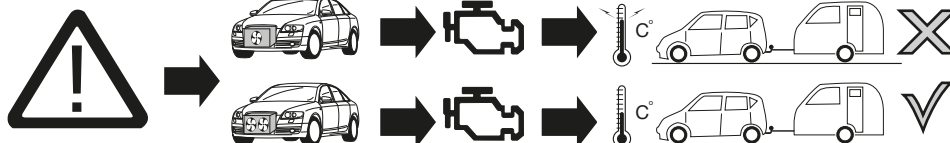

ACHTUNG!

DE

Die Kühlerleistung des Fahrzeuges muß bei Nachrüstung einer Anhängerkupplung möglicherweise erhöht werden! Bitte unbedingt Herstellerangaben beachten!!

ATTENTION!

FR

Il peut s'avérer nécessaire d'augmenter la puissance du radiateur du véhicule lorsque celui est équipé ultérieurement d'un attelage remorque! Respecter impérativement les instructions du constructeur!!

ATTENTIE!

NL

Het koelvermogen van het voertuig moet mogelijk worden verhoogd als achteraf een aanhangerkoppeling wordt aangebracht! Absoluut de fabrieksopgaven in acht nemen a.u.b.!!

ATTENTION!

GB

The vehicle's cooling capacity may have to be increased when retrofitting a trailer coupling! You must observe the manufacturer's instructions!!

¡ATENCIÓN!

ES

¡Es posible que haya que aumentar la capacidad del radiador en caso de reequipar un acoplamiento de remolque! ¡Rogamos tener en cuenta las instrucciones de fabricante sin falta!

ATTENZIONE!

IT

La capacità di raffreddamento del veicolo, quando si applica un gancio di traino, si deve possibilmente aumentare! Si prega di osservare tassativamente le indicazioni del produttore!!

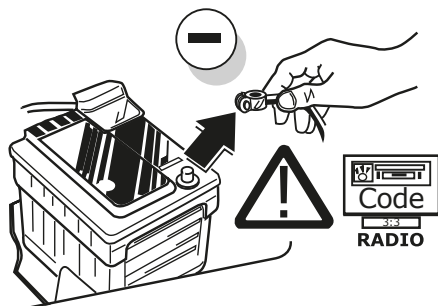

DE

Um Störungen und Schäden am Bordnetz zu vermeiden, muss die Massepolklemme unbedingt vor Beginn aller Arbeiten von der Fahrzeugbatterie getrennt werden! Insbesondere bei Arbeiten und Anschlüssen am CAN-Datenbus kann bei nicht abgeklemmter Batterie sowohl das Anhängermodul als auch das fahrzeugseitige Bordnetzsteuergerät beschädigt werden! Bitte Herstellervorschriften beim Ab- und Anklemmen der Fahrzeugbatterie beachten!

FR

Afin d'éviter tout dys-fonctionnement ou endom-magement du circuit de bord, il est indispensable de débrancher la pince de masse de la batterie du véhicule avant le début de toute opération! En particulier s'il s'agit de travaux et de branchements effectués sur le bus de données CAN, si la batterie n'est pas débranchée, le module remorque aussi bien que le dispositif de commande de circuit de bord du véhicule risquent d'être endommagés! Veuillez respecter les directives du fabricant lors du branchement et du débranchement de la batterie du véhicule!

NL

Om storingen en schade aan de elektrische bedrading te vermijden moet de massapoolklem absoluut vóór aanvang van alle werkzaamheden worden losgekoppeld van de voertuigaccu! Vooral bij werkzaamheden aan en aansluitingen op de CAN-databus kan zowel de aanhangermodule als de voertuigzijdige regeleenheid voor de elektrische installatie beschadigd worden, als de accu niet ontkoppeld is! Fabrieksvoorschriften bij het vast- en loskoppelen van de voertuigaccu in acht nemen a.u.b.!

GB

In order to avoid mal-functions and damage to the vehicle's electrical system the earth terminal must be disconnected from the vehicle's battery before starting work! Both the trailer module and the vehicle's control unit for the electrical system can be damaged during work on the CAN data bus connections if the battery is not disconnected! Please pay attention to the manufacturer's instructions when disconnecting and reconnecting the vehicle's battery!

ES

¡Para evitar fallos y defectos en el sistema eléctrico de a bordo es imprescindible separar al terminal de puesta a tierra de la batería del vehículo antes de realizar cualquier trabajo! ¡Particularmente al realizar trabajos y conexiones al bus de datos CAN puede estropearse tanto el módulo para remolques como el regulador del sistema eléctrico de a bordo del vehículo si no se ha desconectado la batería! ¡Rogamos observar las instrucciones del fabricante al conectar y desconectar la batería del vehículo!

IT

Per evitare disturbi e danni alla rete di distribuzione elettrica, l'espansione polare a massa deve essere assolutamente scollegata dalla batteria del veicolo prima dell'inizio dei lavori! In particolare durante i lavori e gli allacciamenti al bus di dati CAN, se la batteria non è scollegata si possono danneggiare sia la centralina rimorchio, sia la centralina della rete di distribuzione elettrica del veicolo! Attenersi alle indicazioni del costruttore per scollegare e ricollegare la batteria del veicolo!

ID.3

2

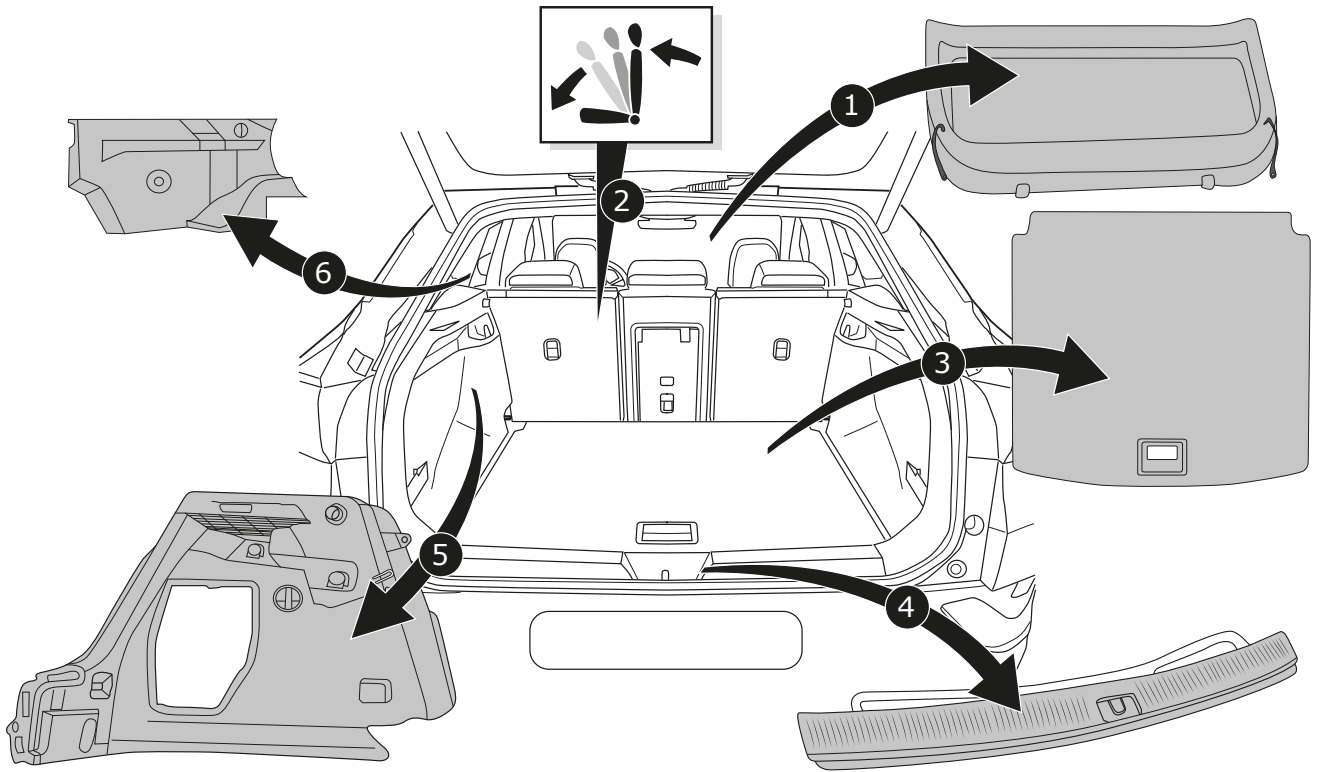

ID.4

3

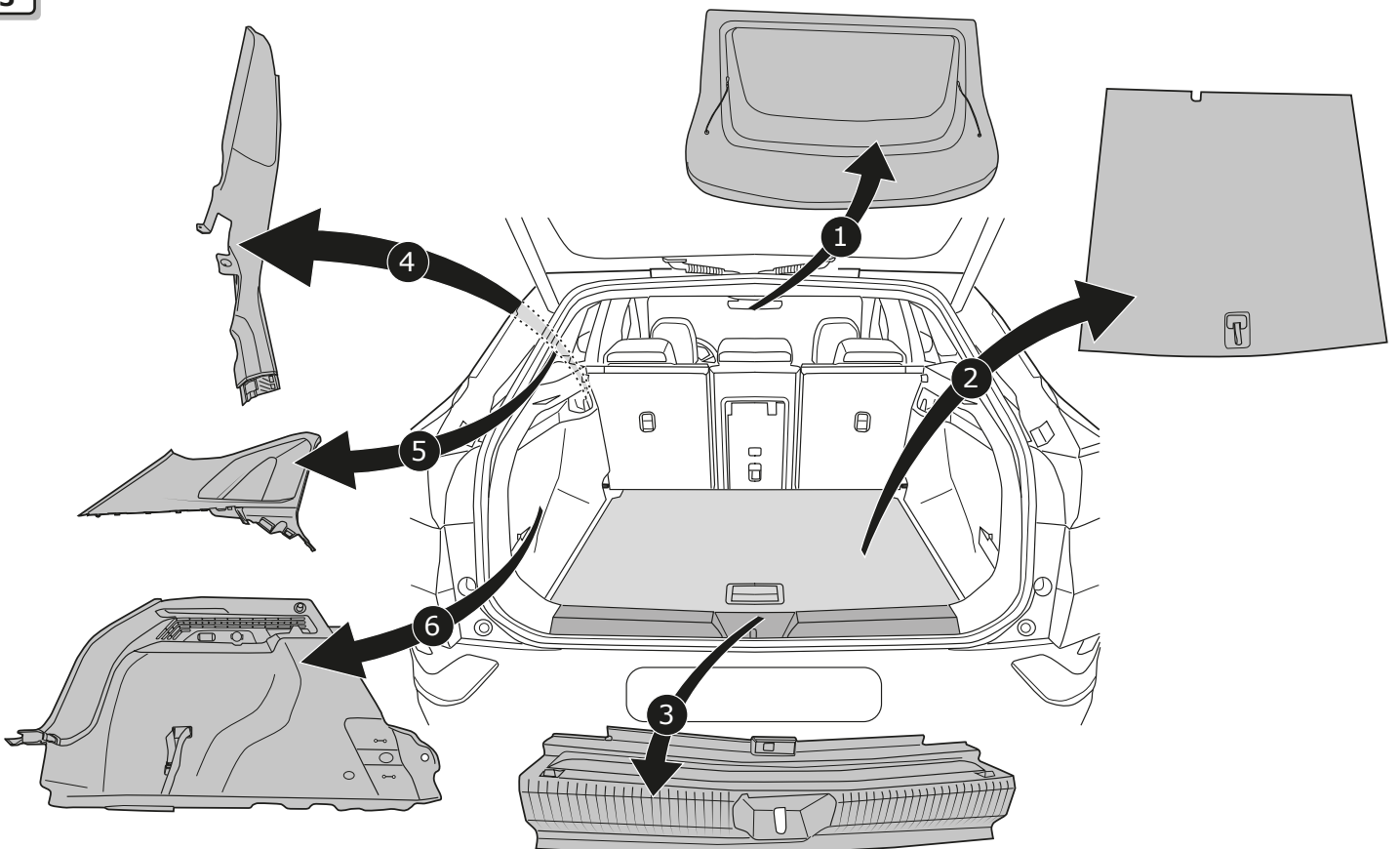

4

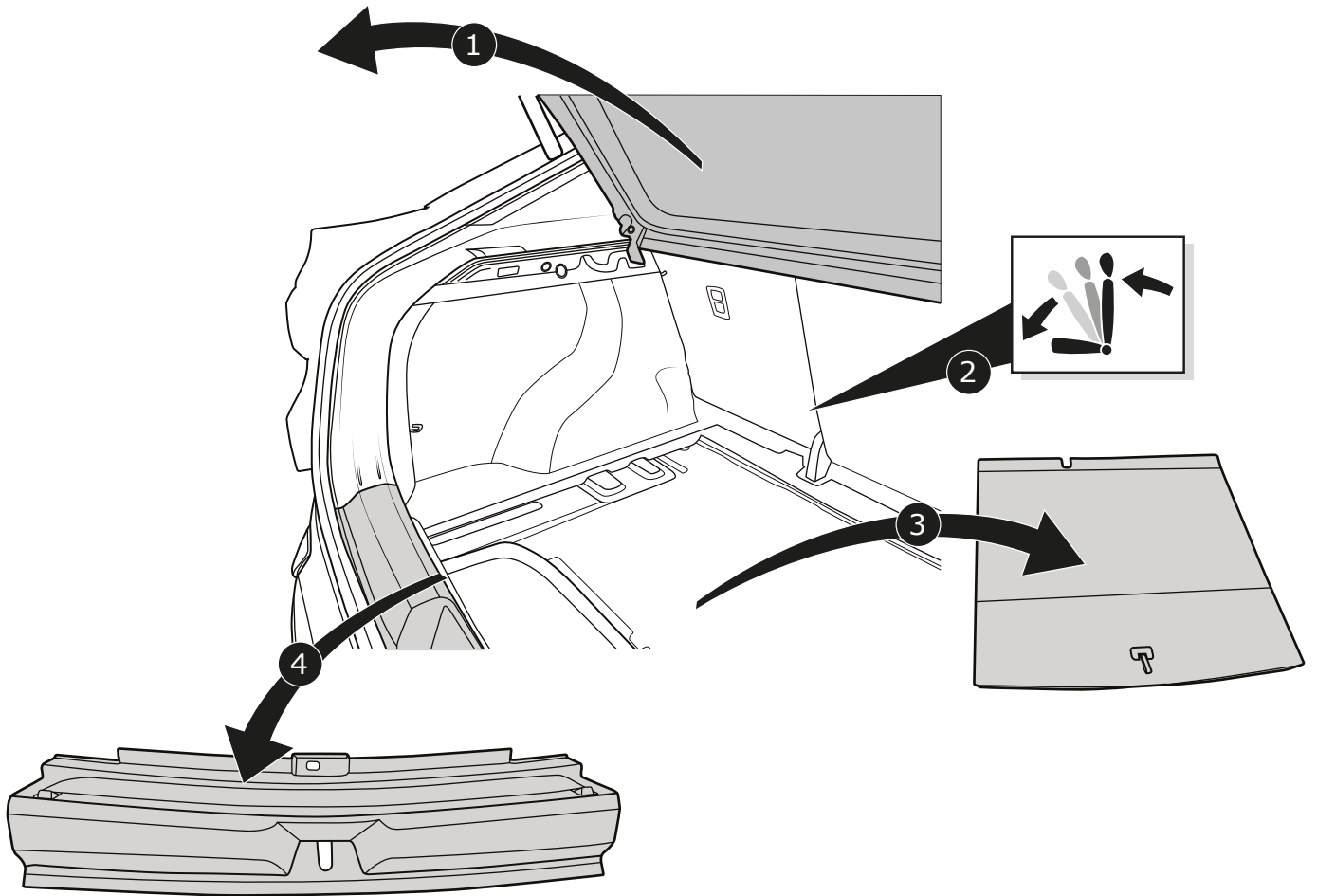

5

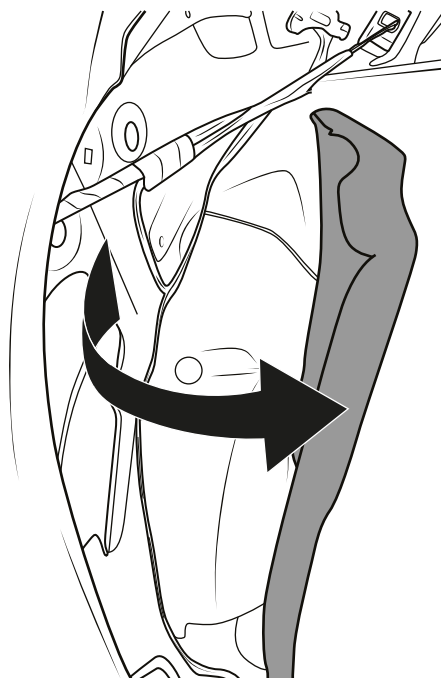
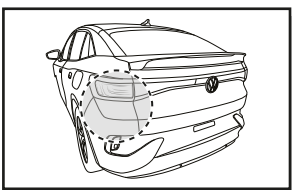

6

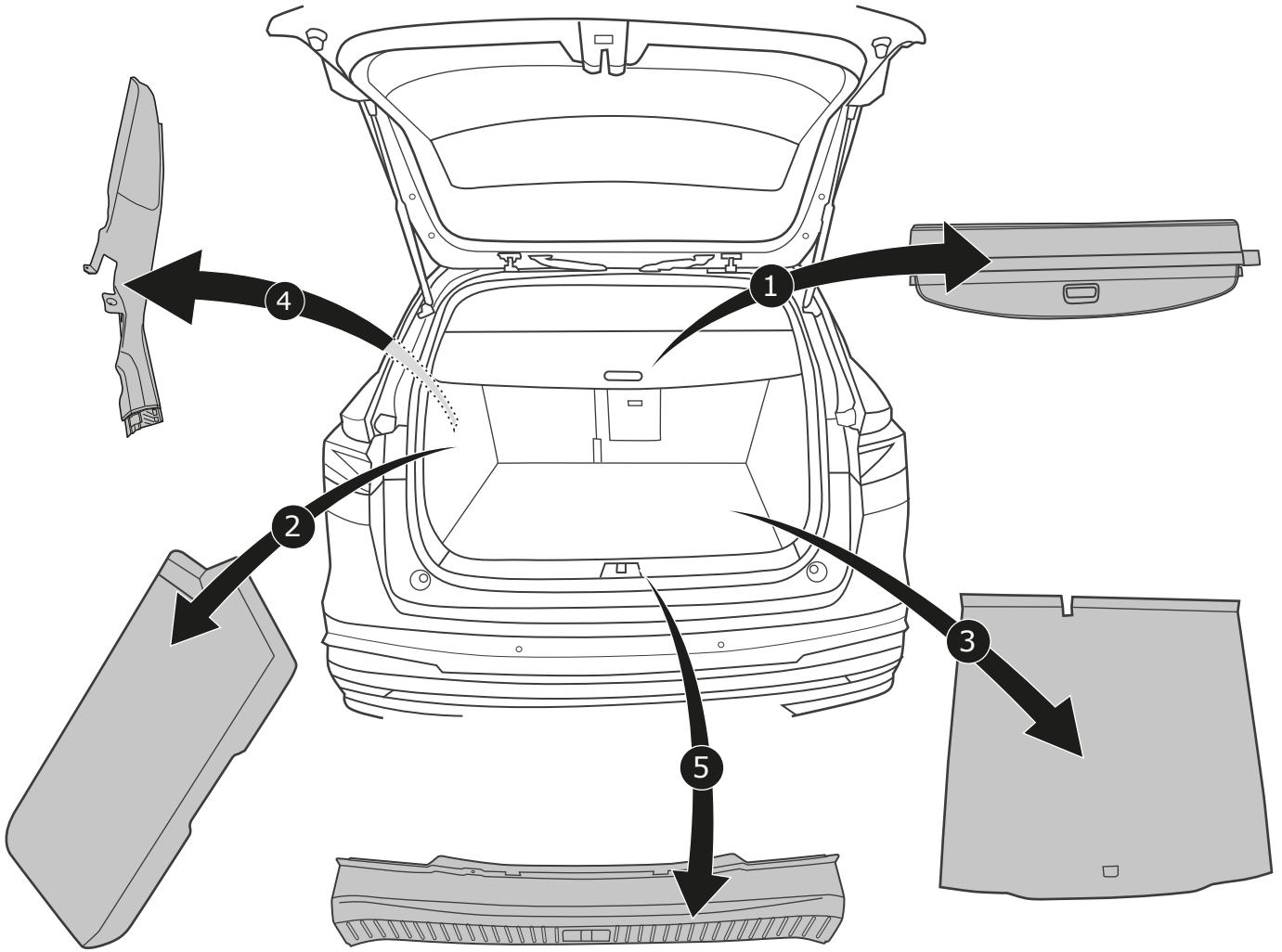

7

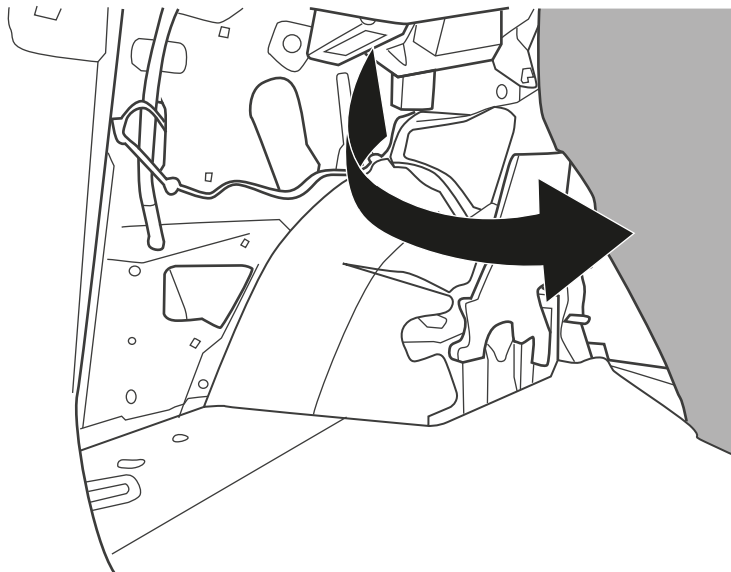
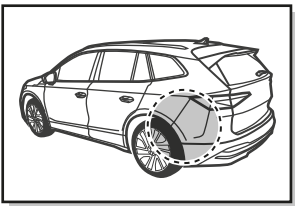

ID.3

8

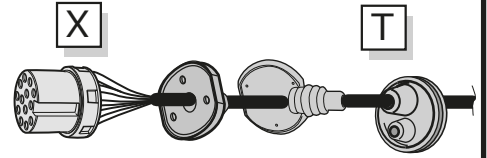
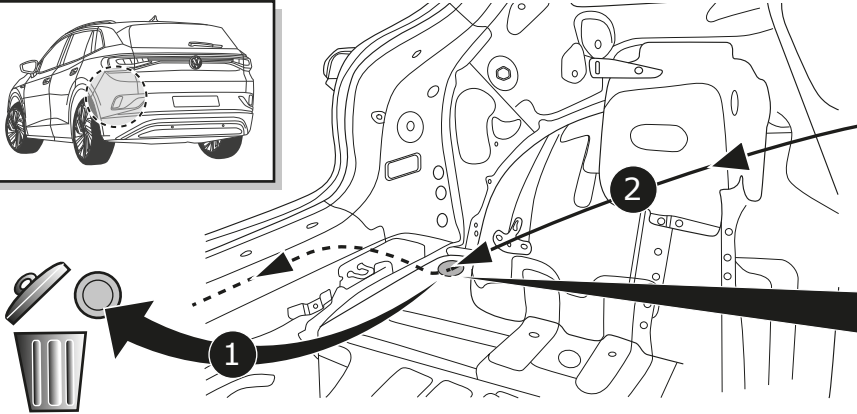
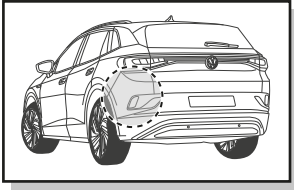

ID.4

9

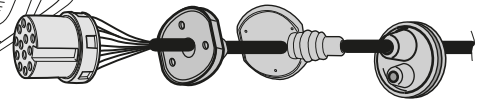
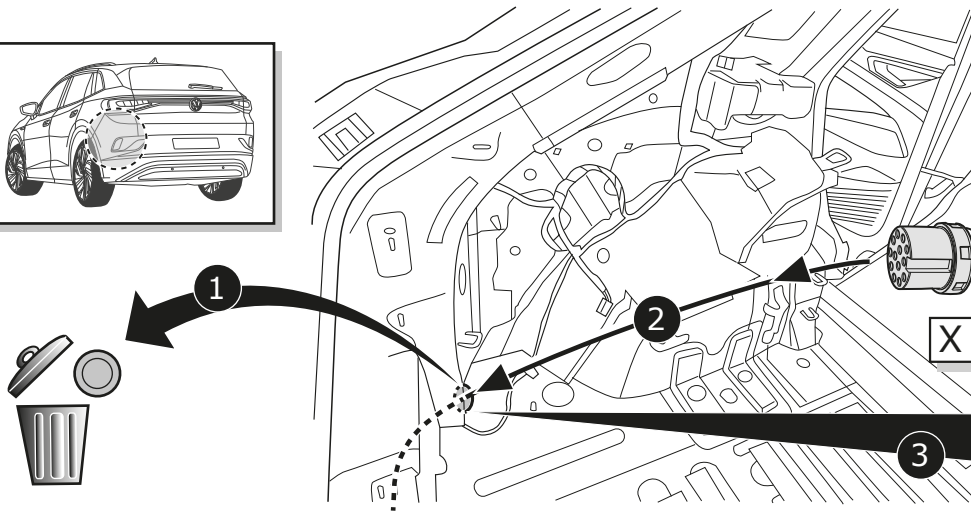
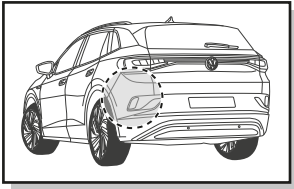

ID.5

10

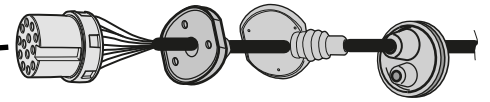
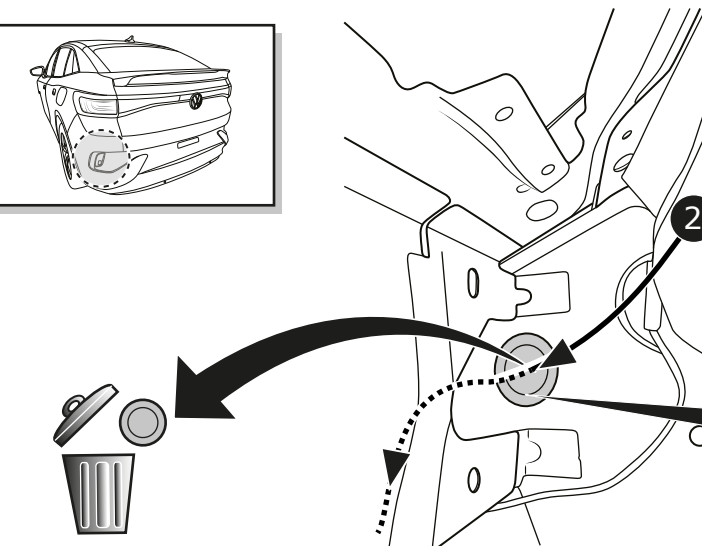
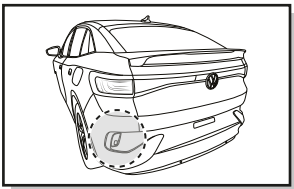

ENYAQ IV

11

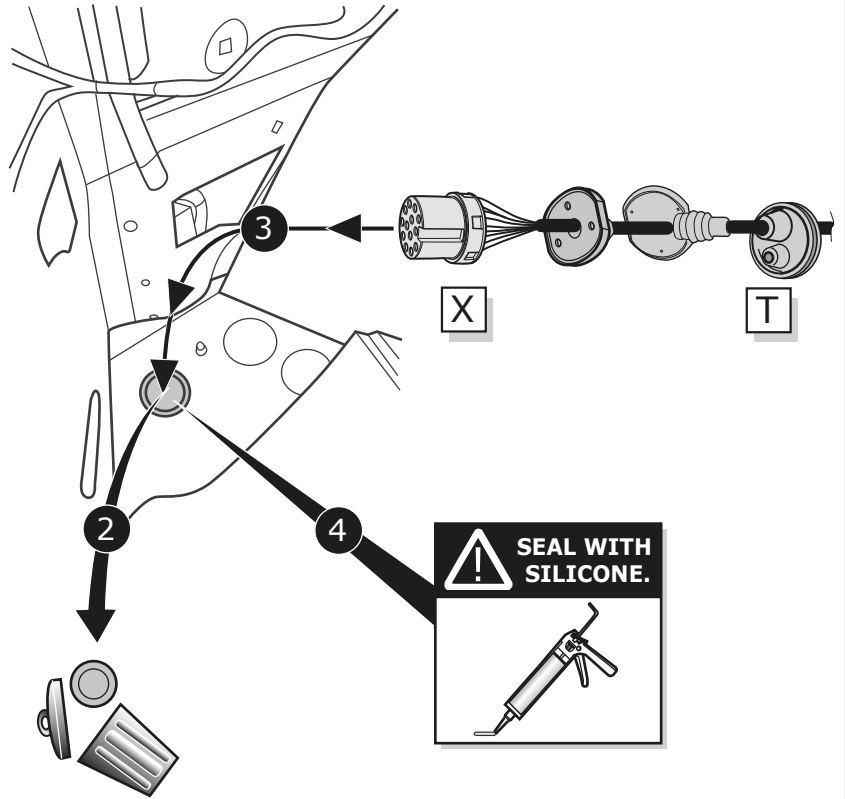
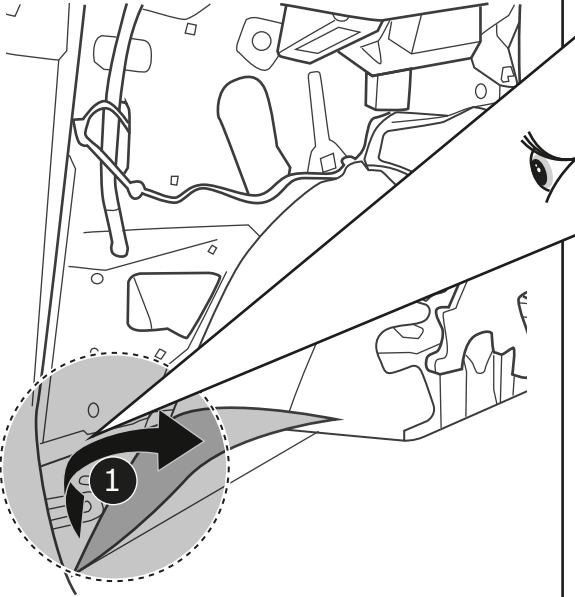
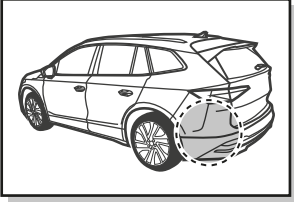

All models

12

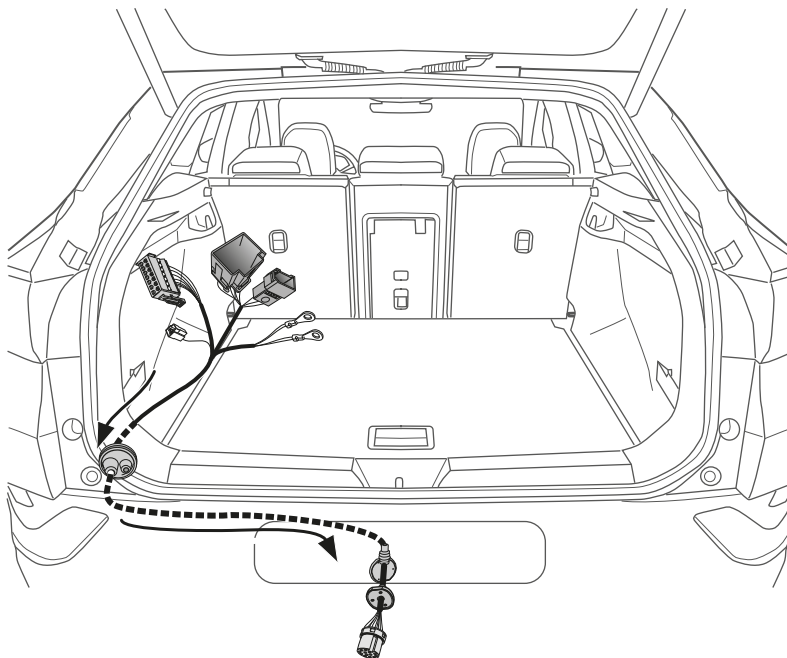

13

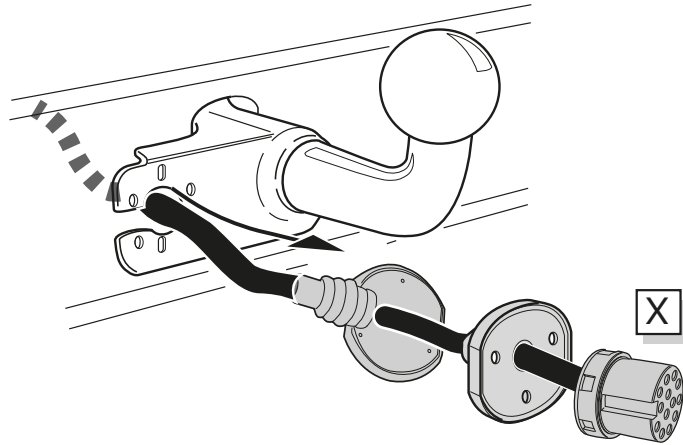

14

- Ⓓ Anschluss Steckdose
- Ⓕ Connection de la prise
- Ⓓ Contactdoos aansluiting
- Ⓖ Socket connection
- Ⓔ Conexión de la caja de enchufe
- Ⓘ Allaccio zoccolo



Page 33

15

Option 1

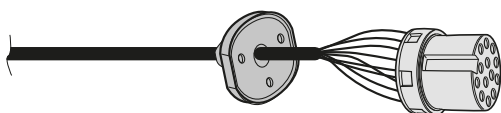
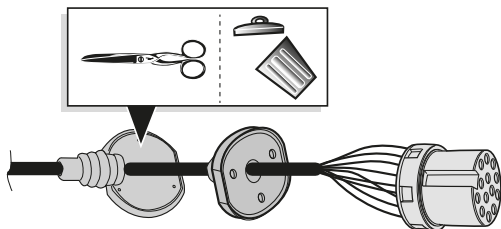

Option 2

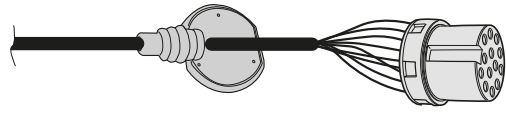
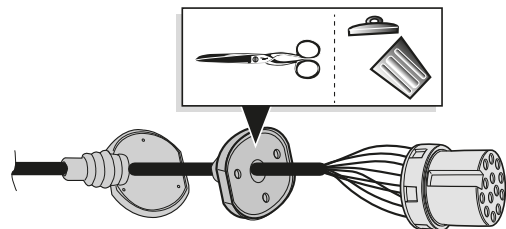

16

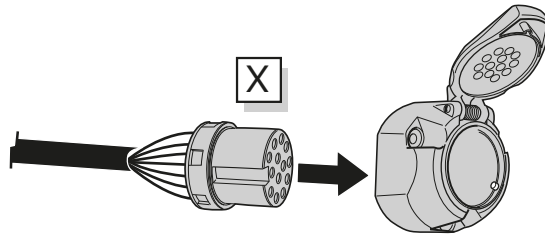

17

Option 1

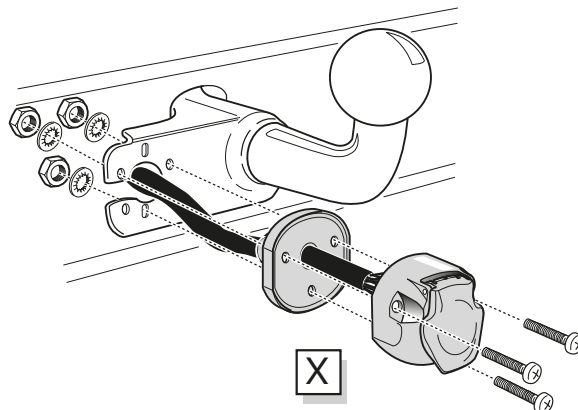

18

Option 2

1

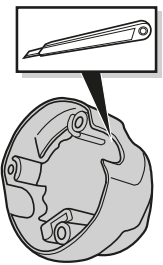

2

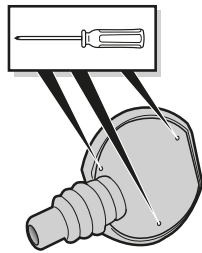

3

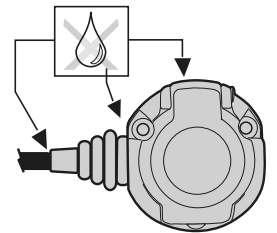
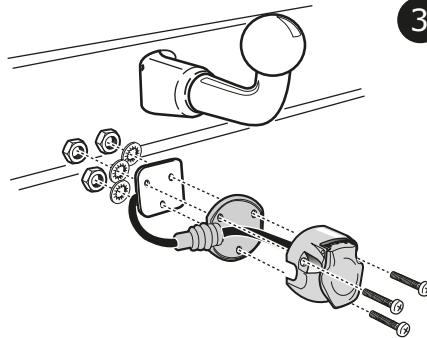

19

Option 3

1

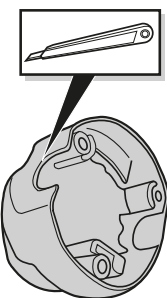

2

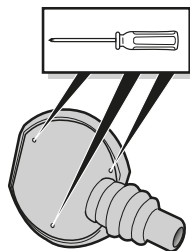

3

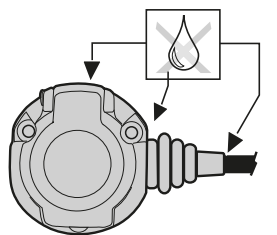
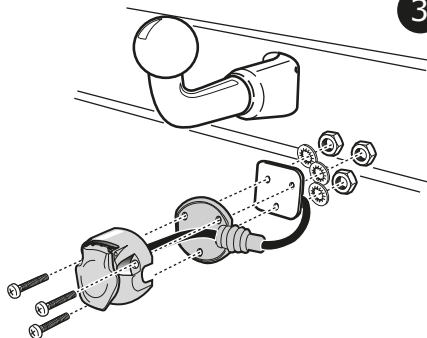

20

1

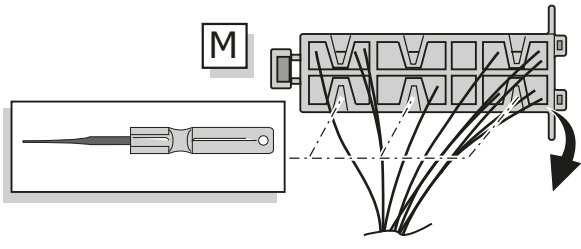

2

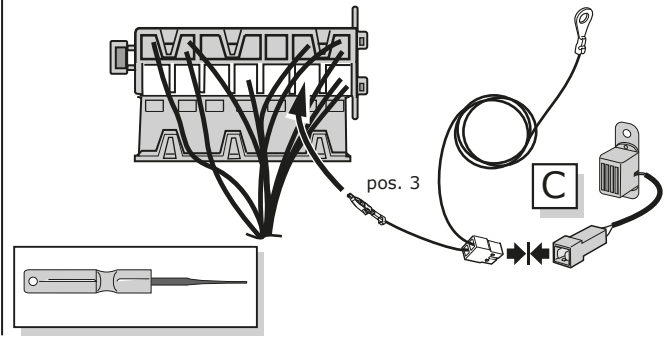

M

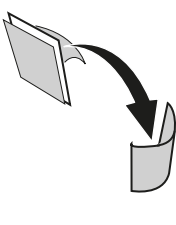
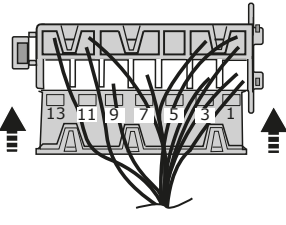

3

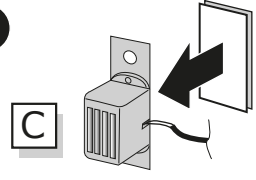

4

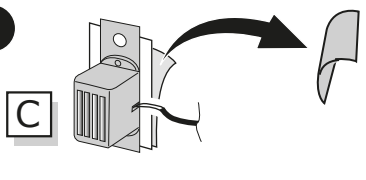

21

1

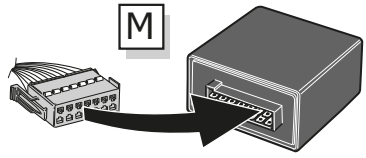

2

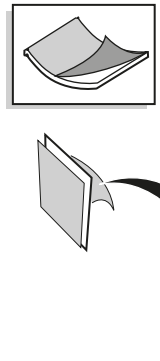

3

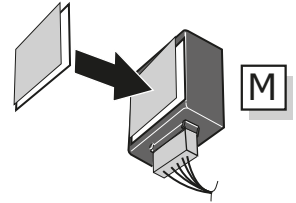

4

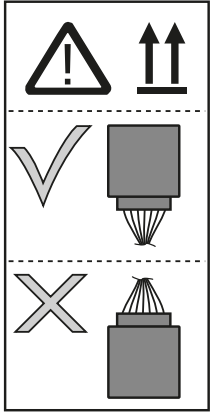
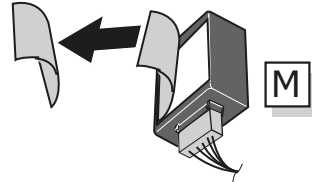

ID.3

22

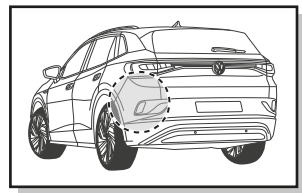

1

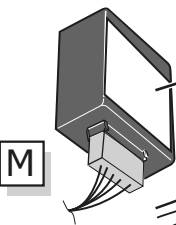

2

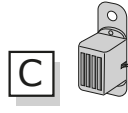

3

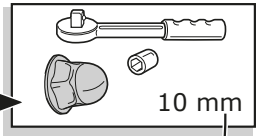

4

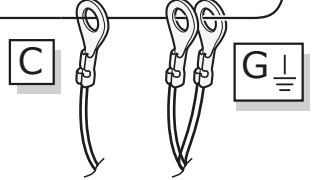

ID.4

23

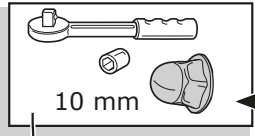
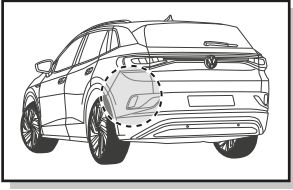

10 mm

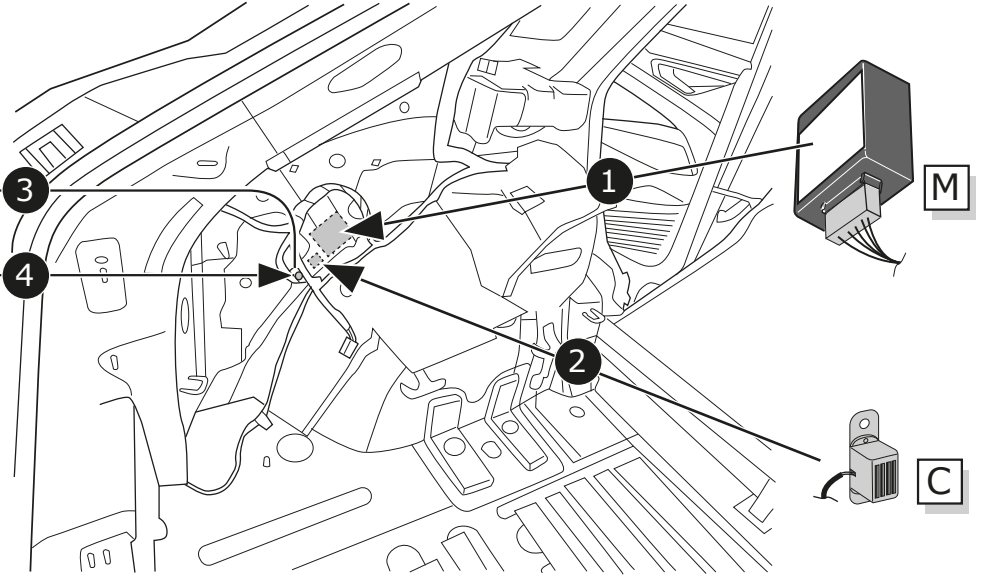

ID.5

24

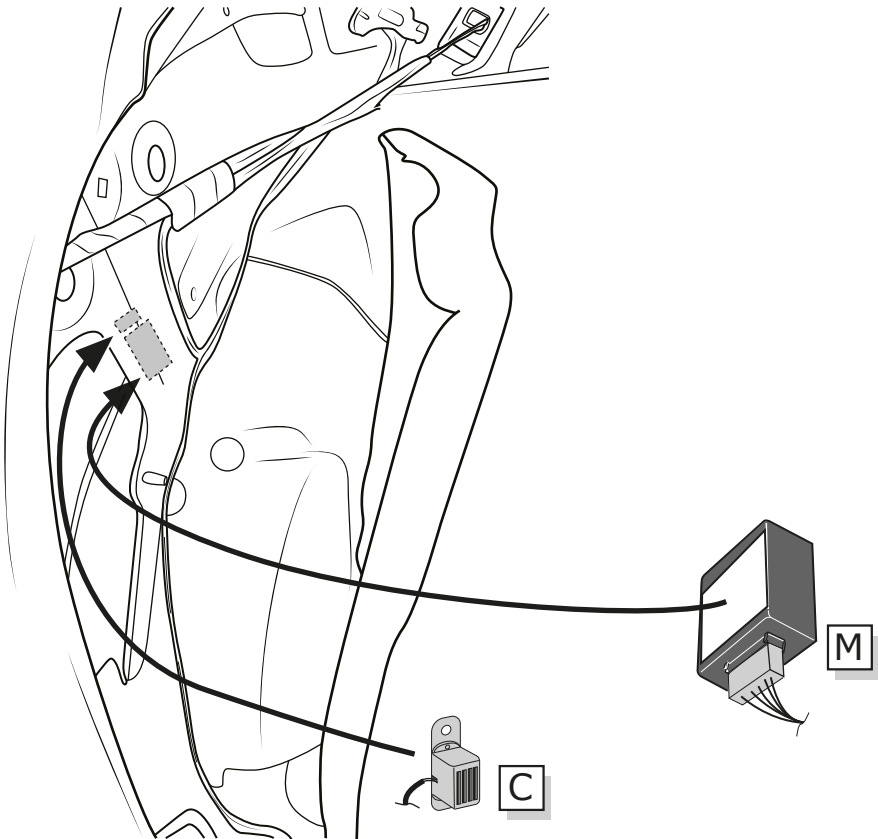
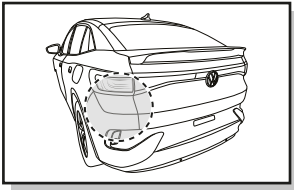

25

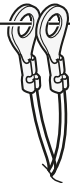
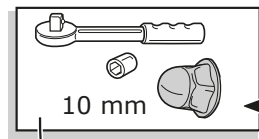
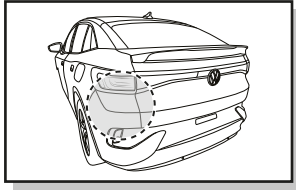

1

2

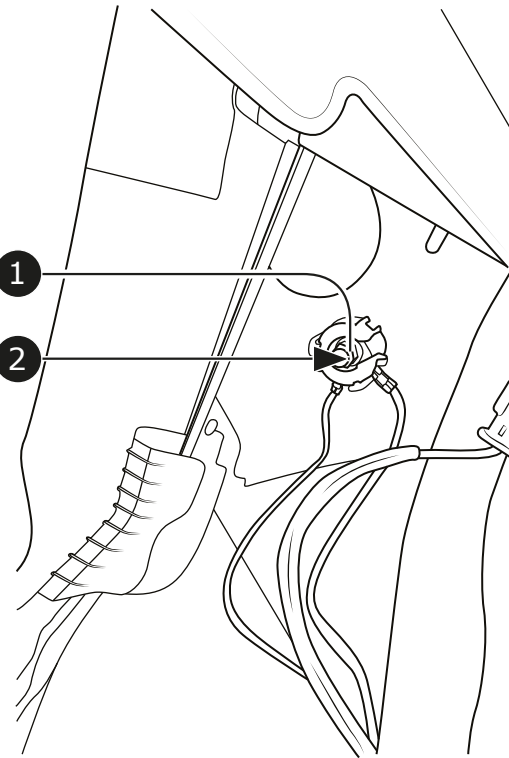

ENYAQ IV

26

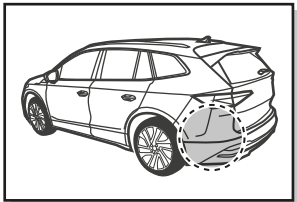

C

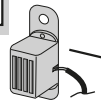

2

M

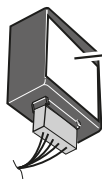

1

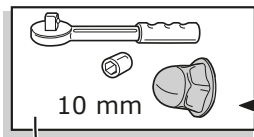

3

4

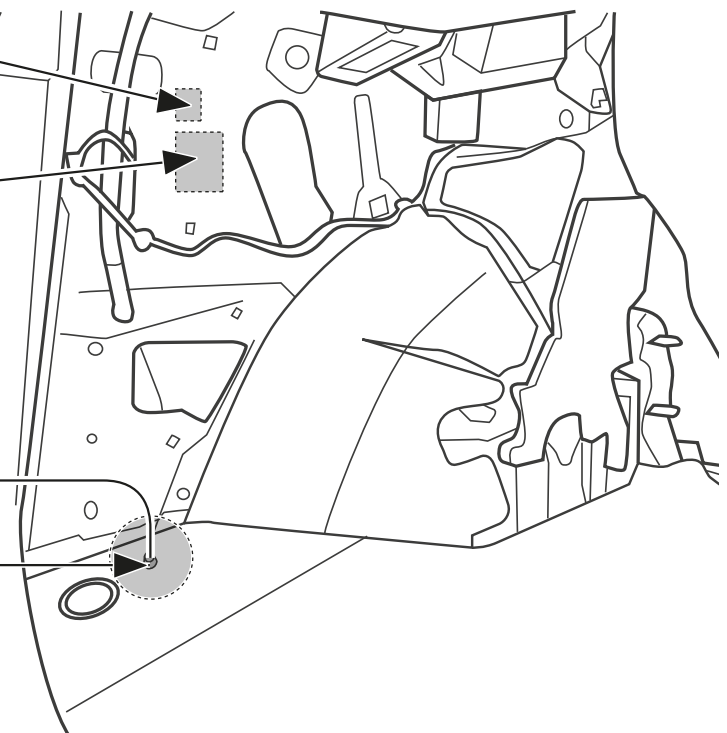

27

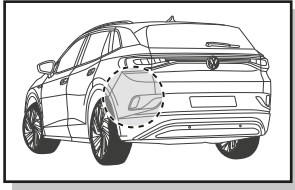

BK/PE
6 pin

BK
10 pin

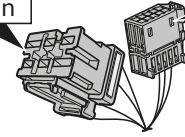

Vehicle **with** trailer preparation
Fahrzeuge **mit** Anhänger Vorbereitung



28 → 29

55 → 65

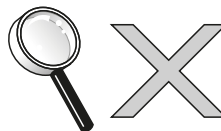
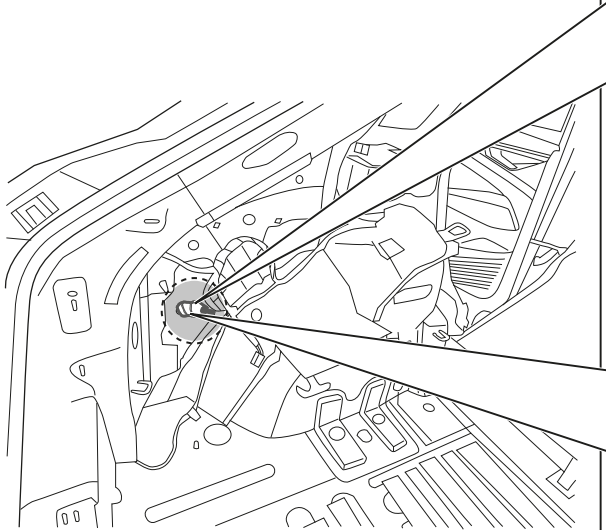

BK/PE
6 pin

BK
10 pin

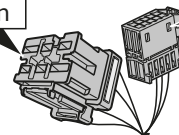

Vehicle **without** trailer preparation
Fahrzeuge **ohne** Anhänger Vorbereitung



30 → 65

Vehicle **with** trailer preparation / Fahrzeuge **mit** Anhänger Vorbereitung

28

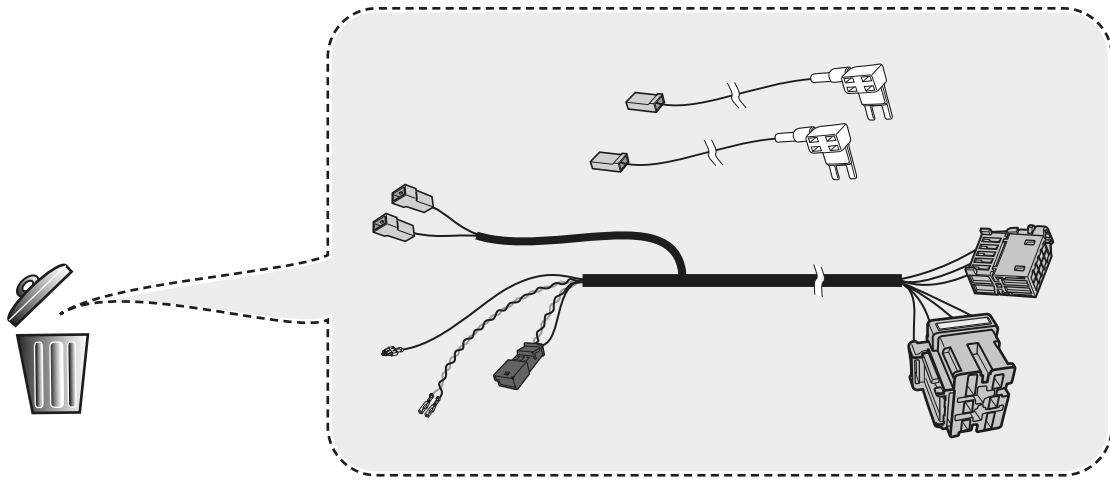

29

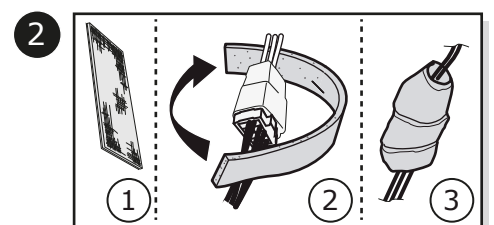
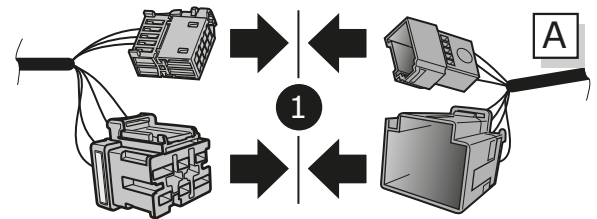
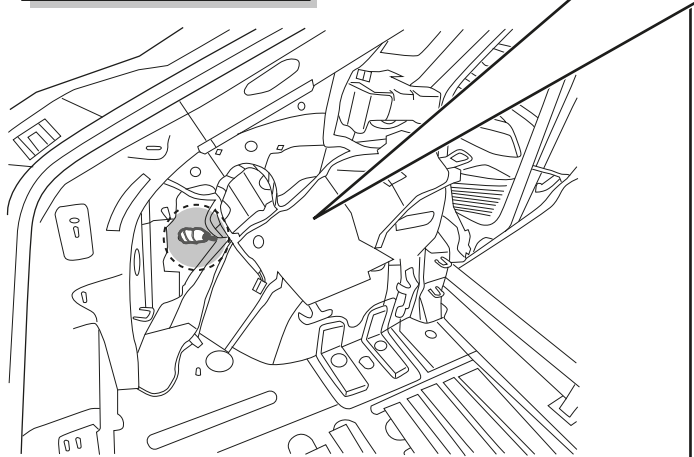
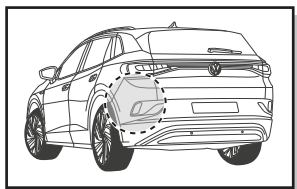

Vehicle **without** trailer preparation / Fahrzeuge **ohne** Anhänger Vorbereitung

30

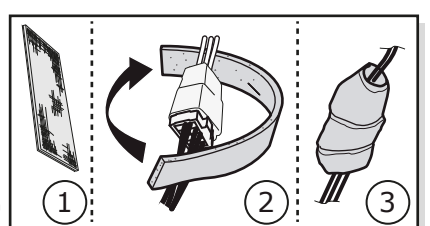
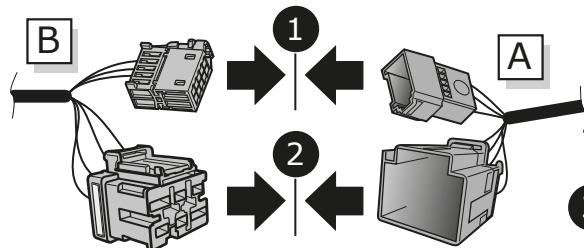
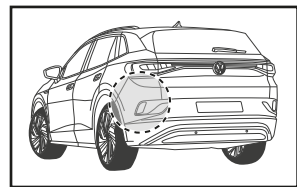

31

ID.3

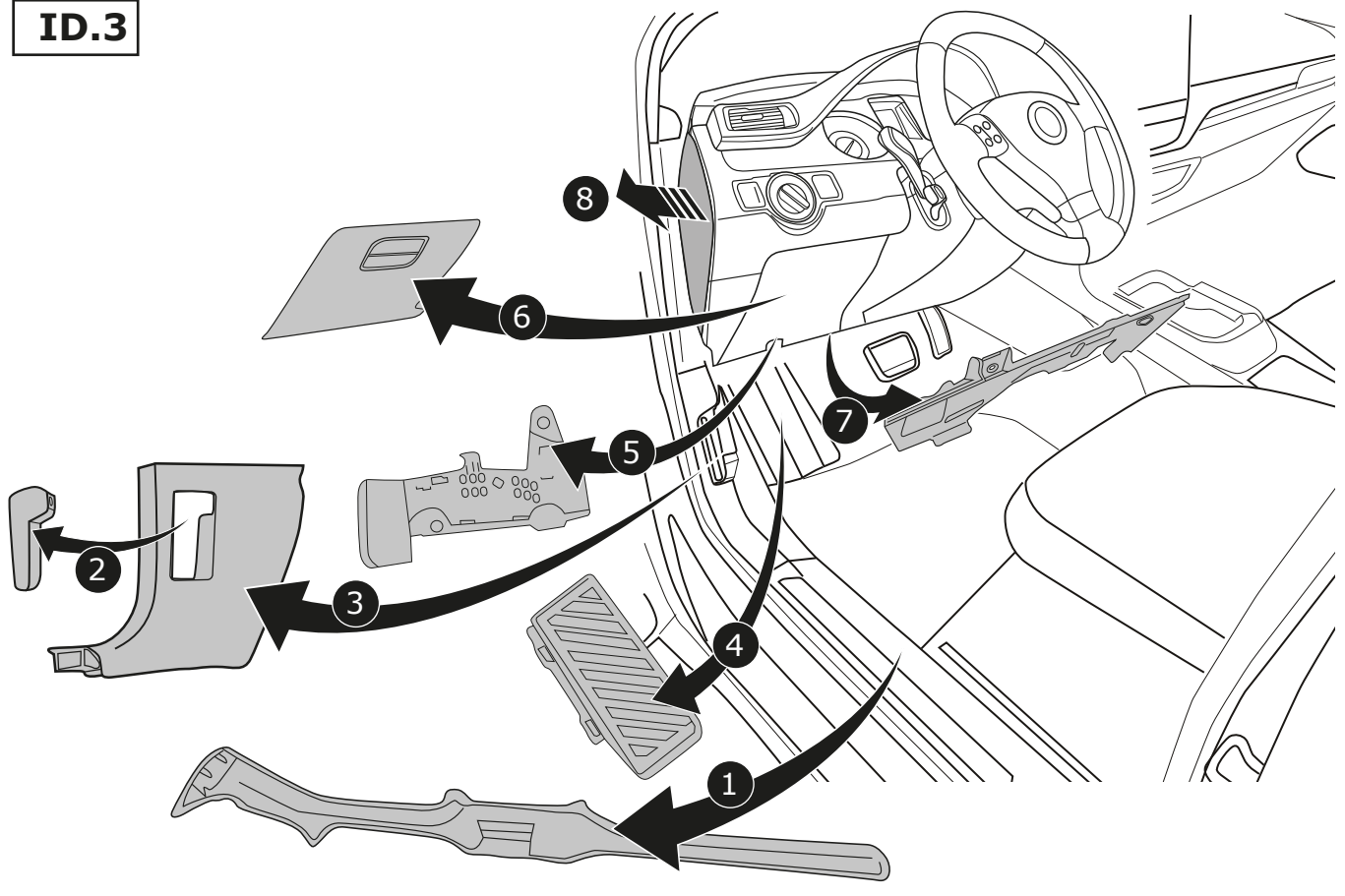

32

ID.4

ID.5

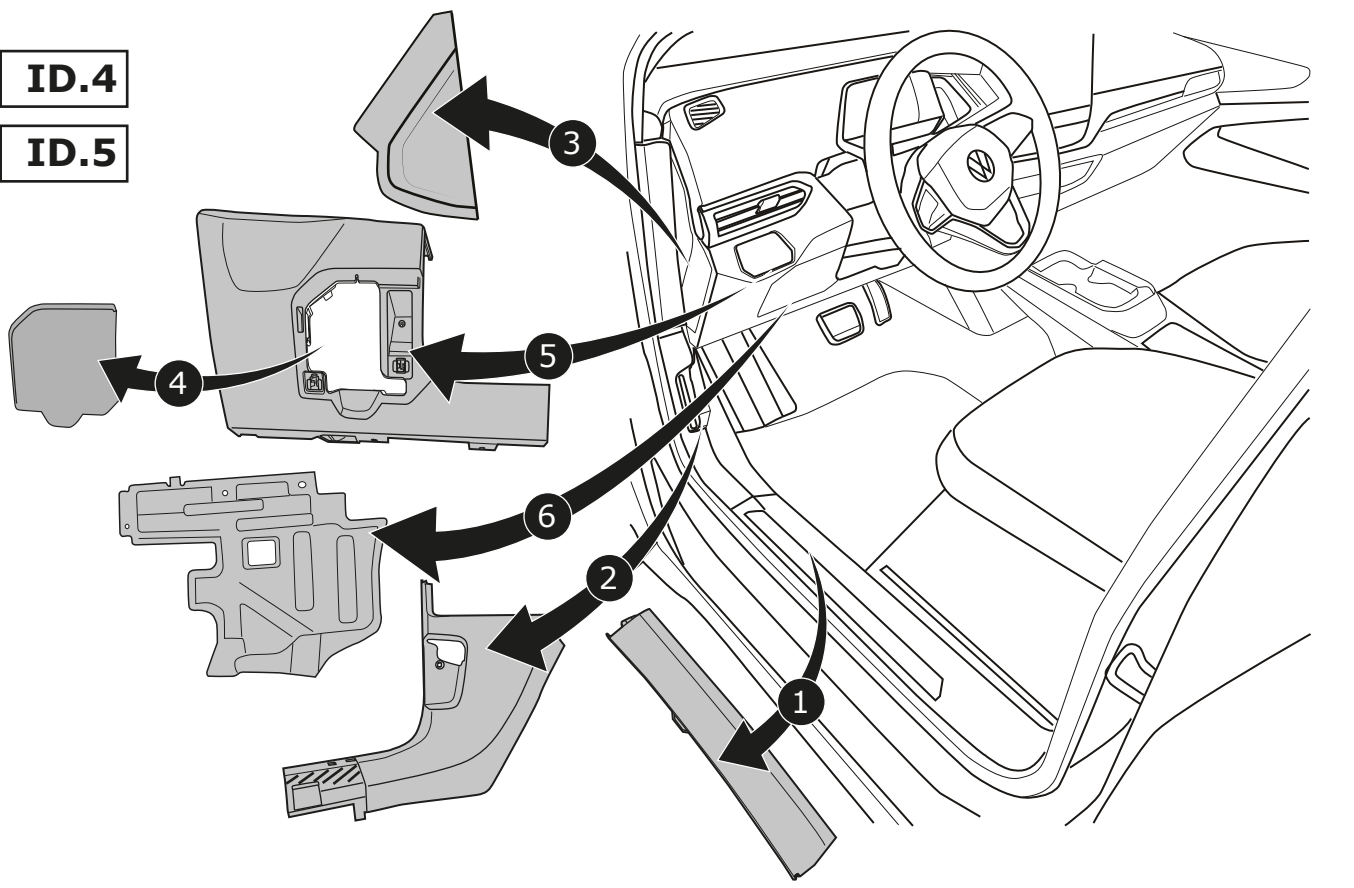

33

ENYAQ IV

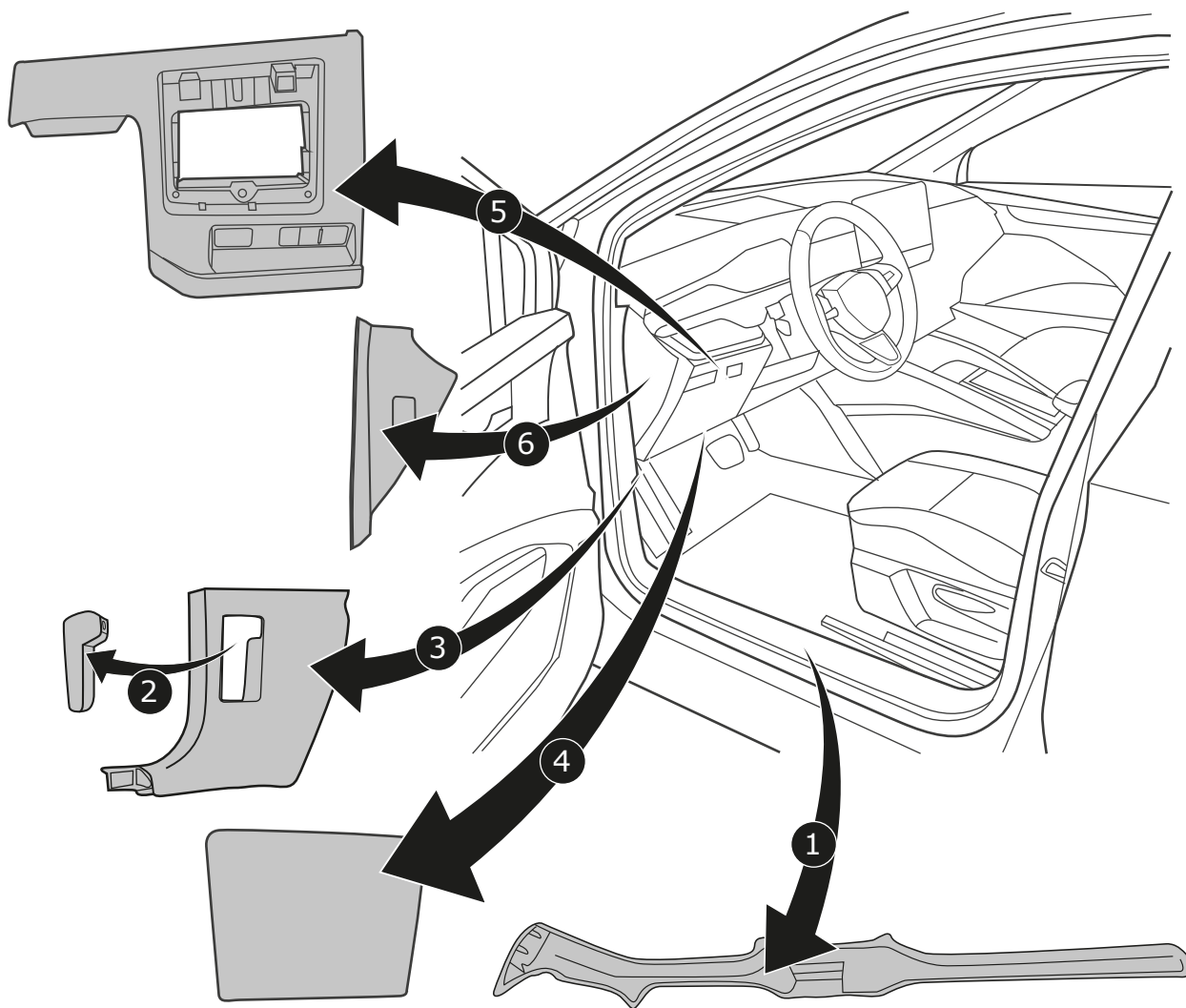

34

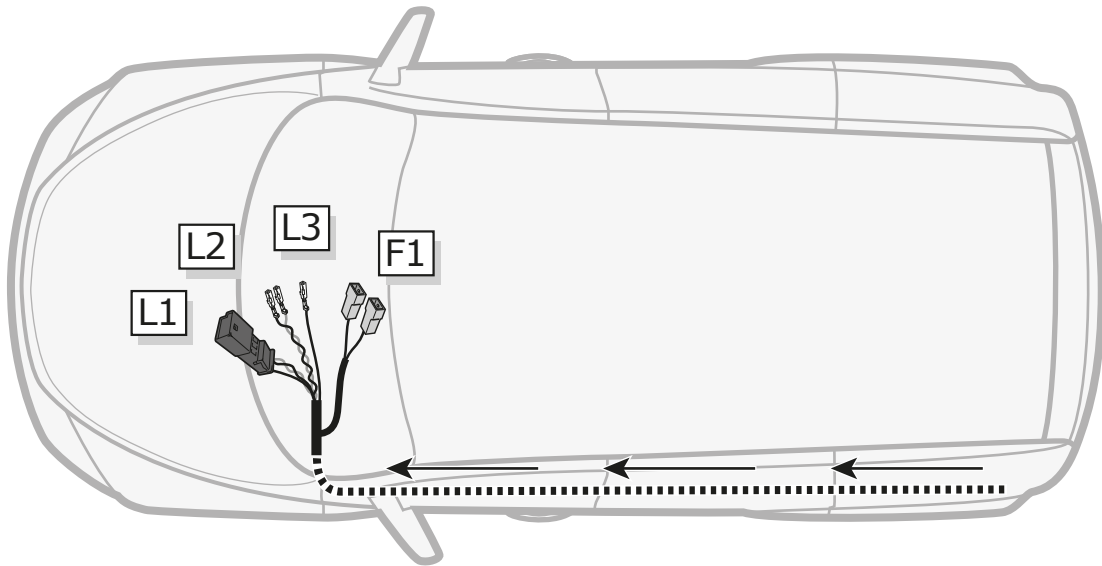

35

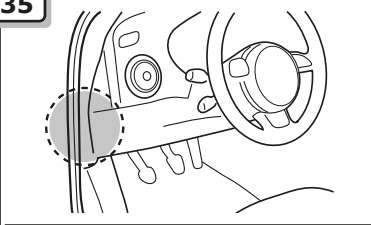

ID.3
ID.5
ENYAQ IV

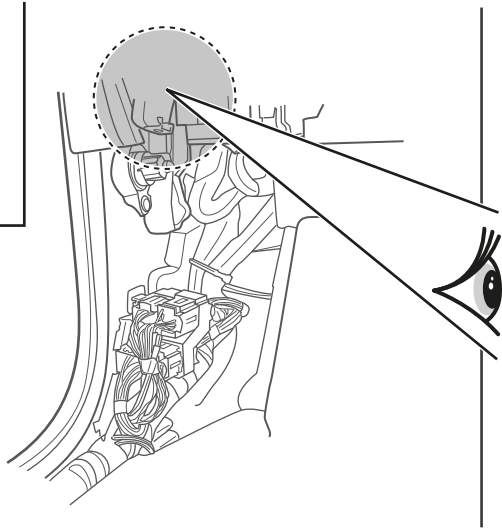

Body Control Module

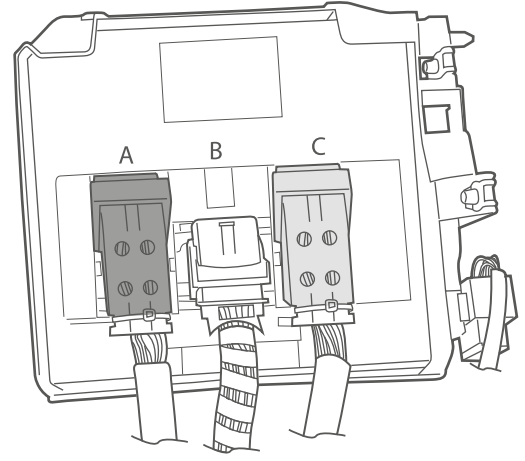

36

ID.3
ID.5
ENYAQ IV

Body Control Module

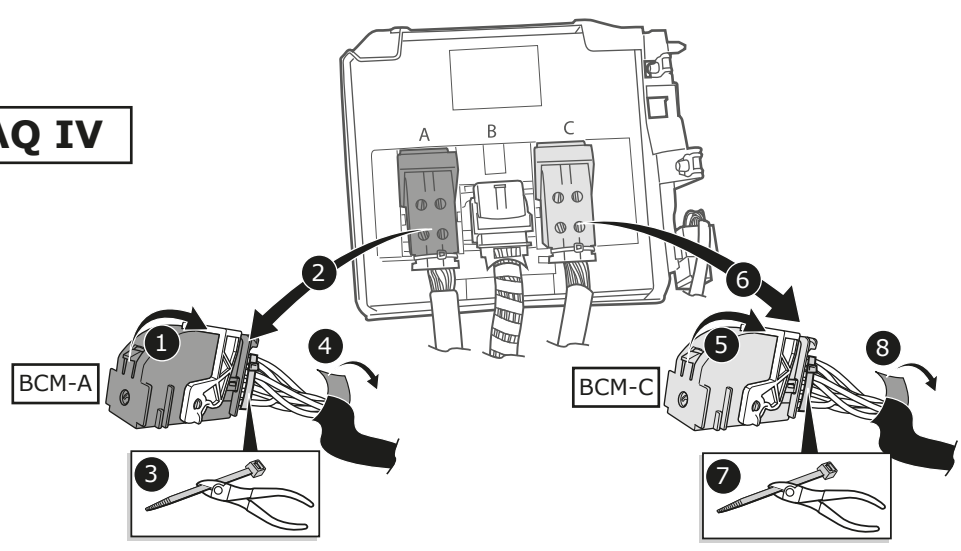

37

ID.3
ID.5
ENYAQ IV

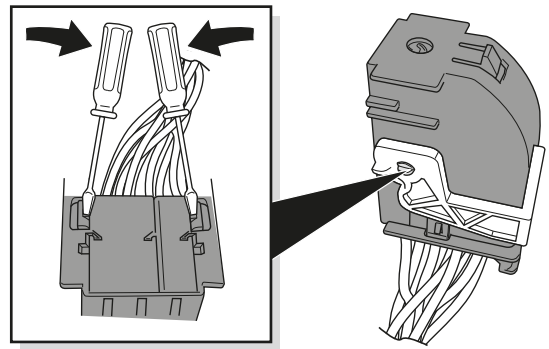

1 2

BCM-A

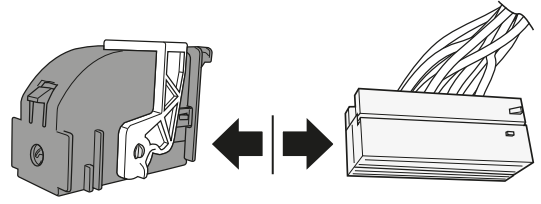

3

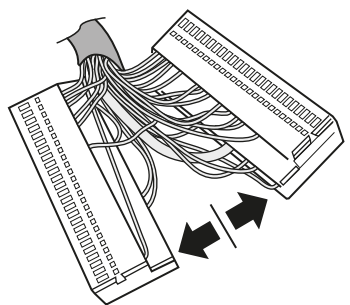

38

ID.3
ID.5
ENYAQ IV

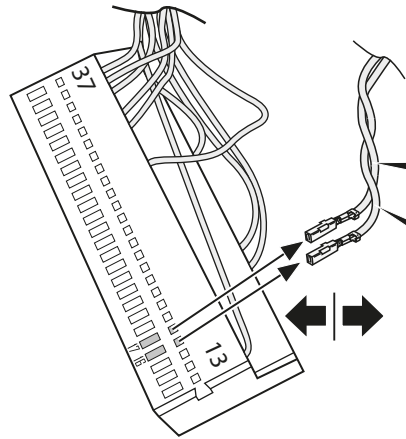

CAN L	OG/BN Pos. 17
CAN H	OG/GN or GN Pos. 16

Can-bus
Datawire

BCM-A

39

ID.3
ID.5
ENYAQ IV

CAN H	OG/GN or GN Pos. 1
CAN L	OG/BN Pos. 3

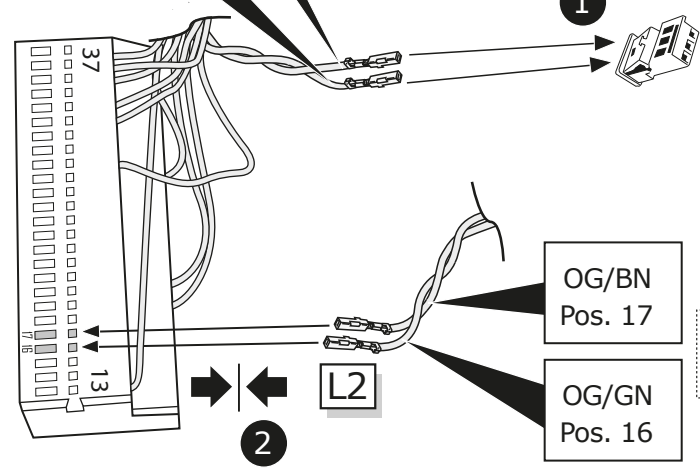

1

2

OG/BN Pos. 17
OG/GN Pos. 16

Can-bus
Datawire

BCM-A

40

ID.3
ID.5
ENYAQ IV

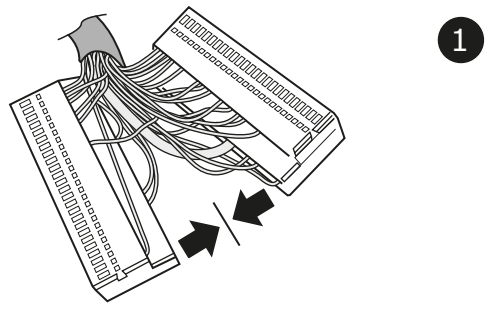

1

BCM-A

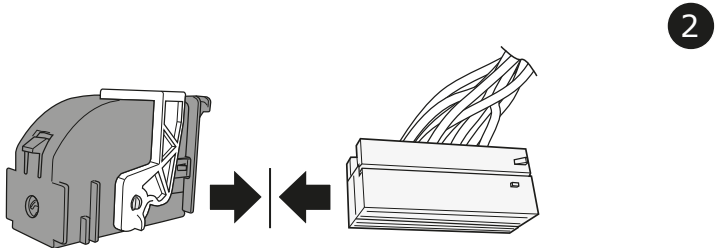
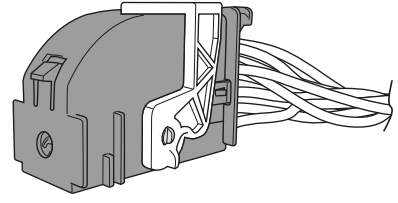

2

41

ID.3
ID.5
ENYAQ IV

BCM-C

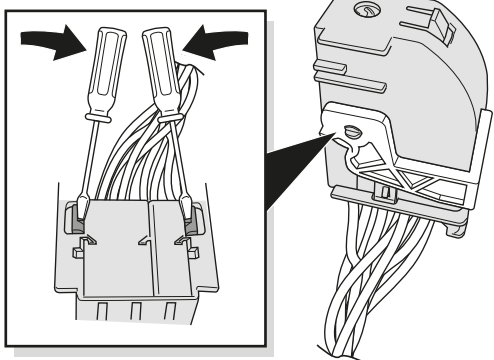

1

2

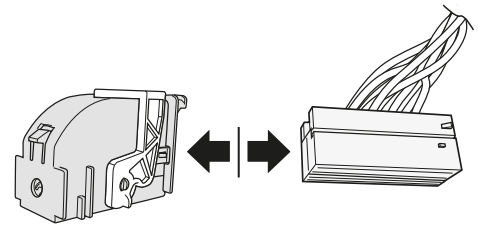

3

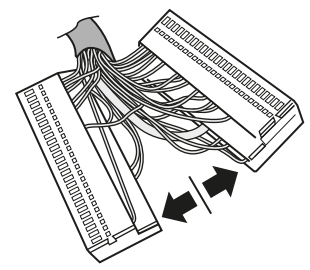

42

ID.3
ID.5
ENYAQ IV

BCM-C

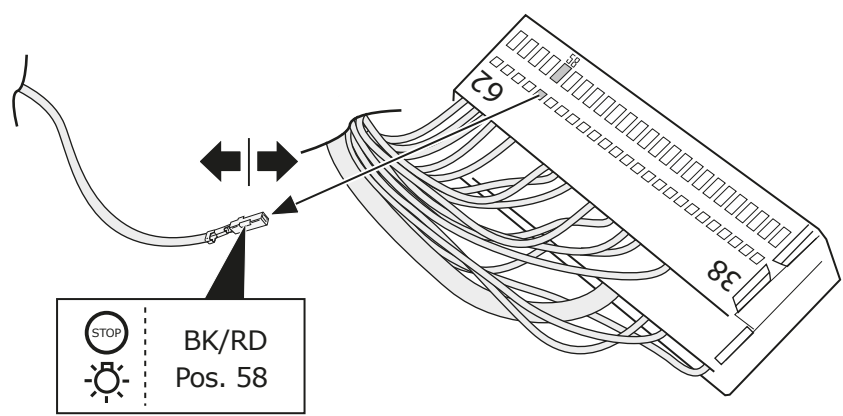

 BK/RD
 Pos. 58

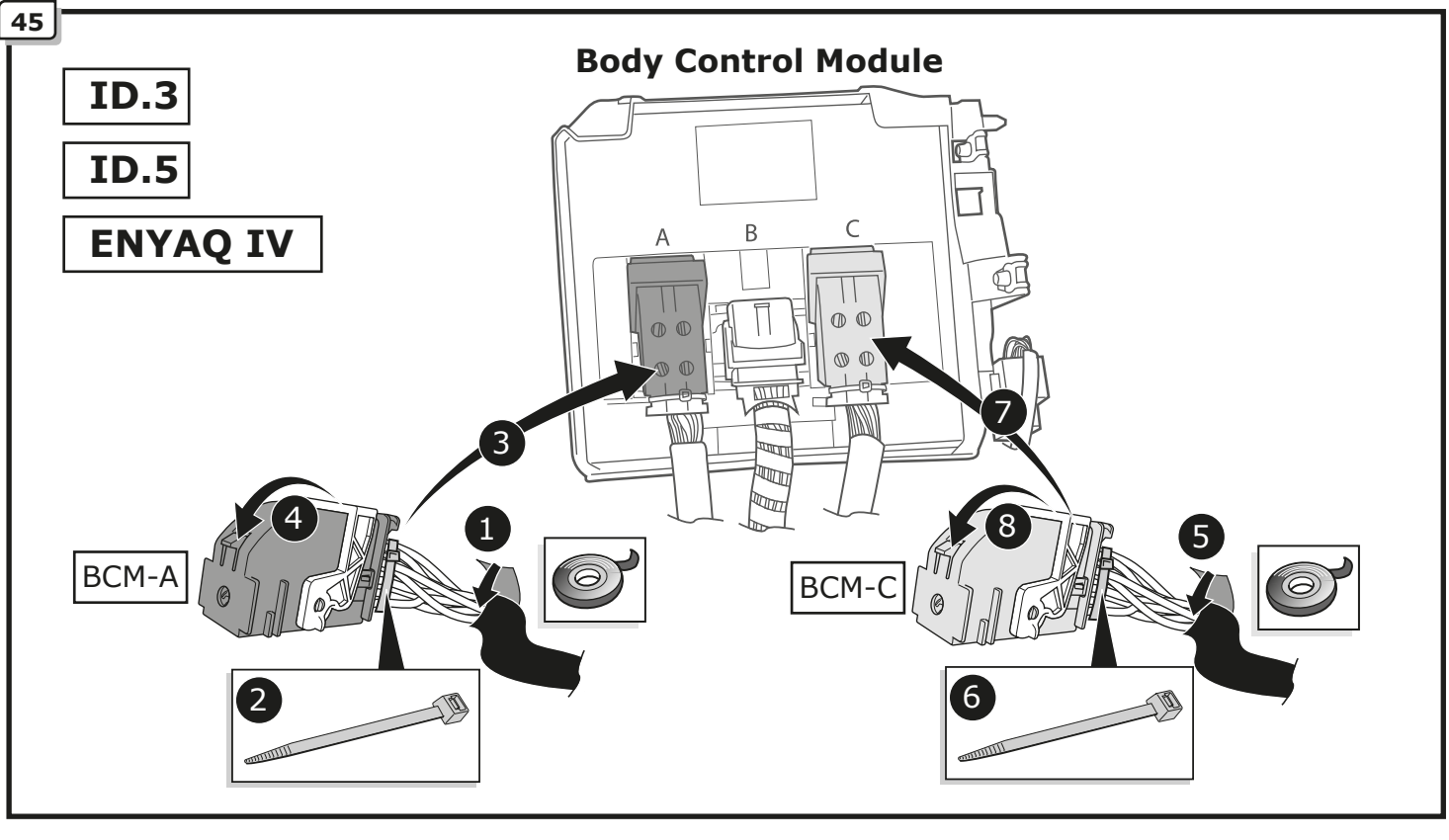
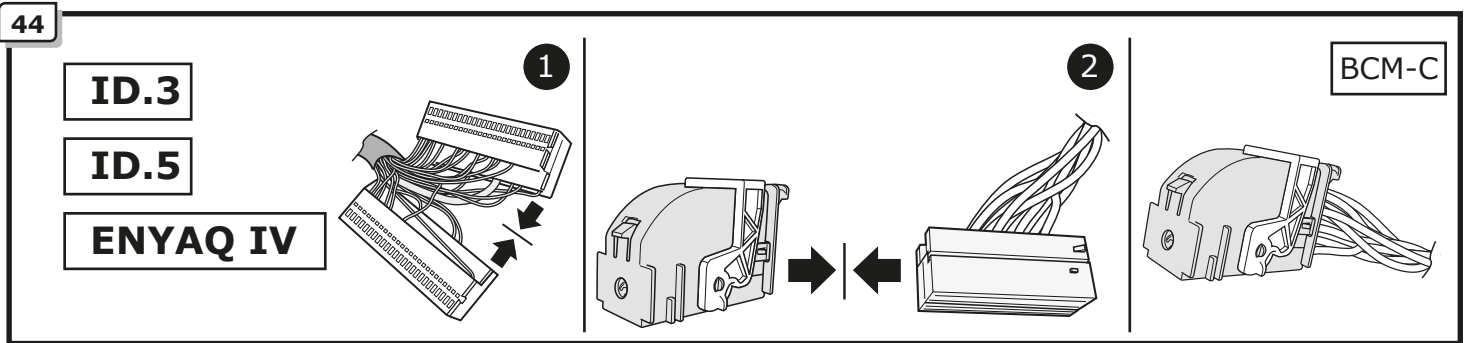
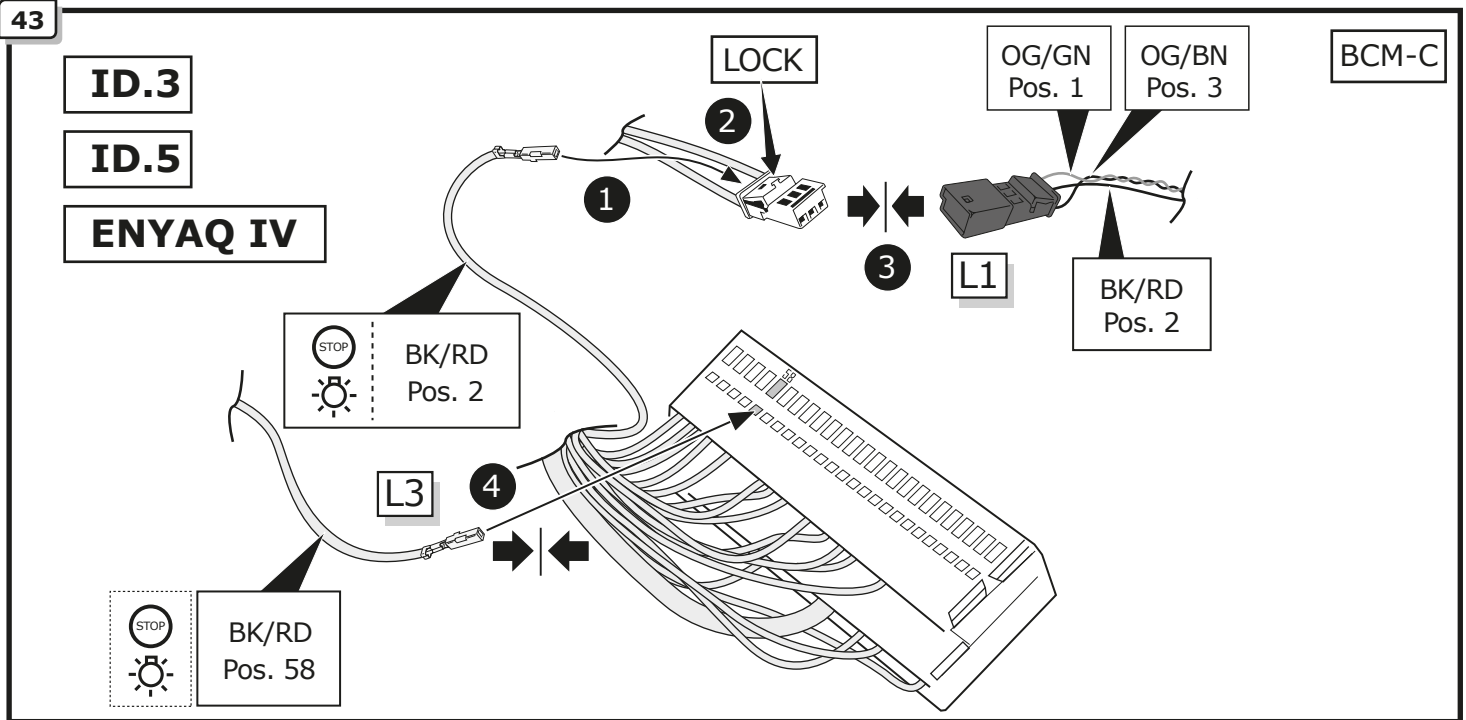

46

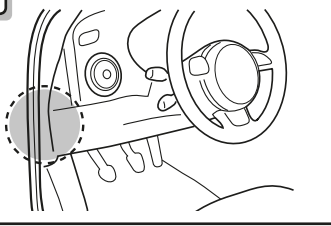

ID.4

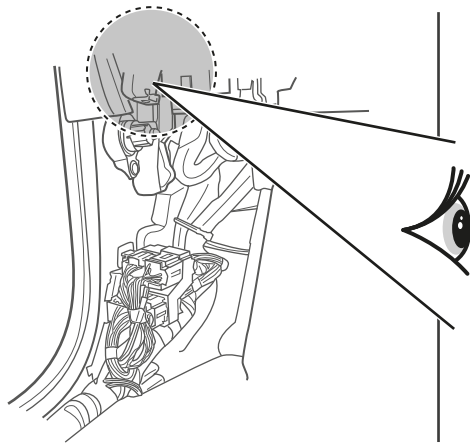

Body Control Module

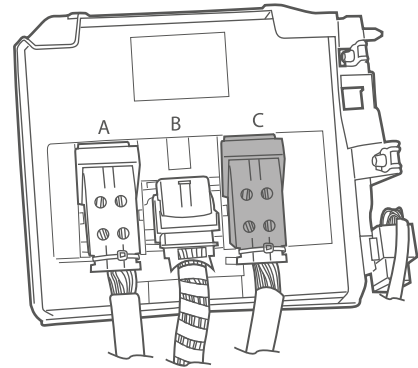

47

ID.4

Body Control Module

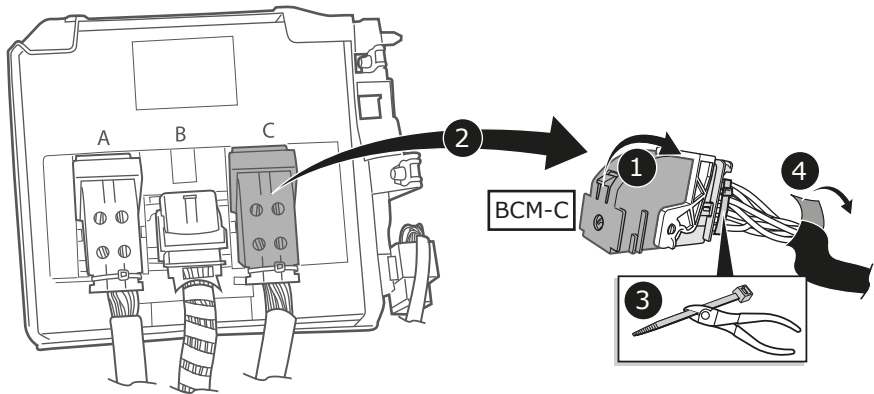

48

ID.4

BCM-C

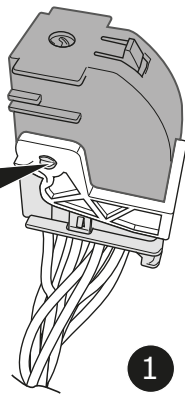
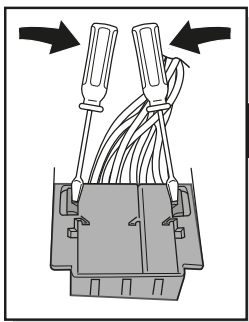

1

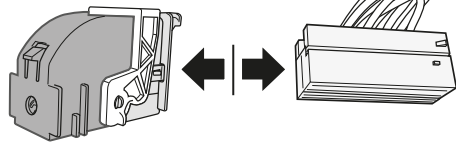

2

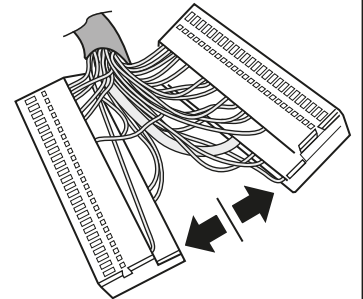

3

49

ID.4

BCM-C

STOP
BK/RD
Pos. 58

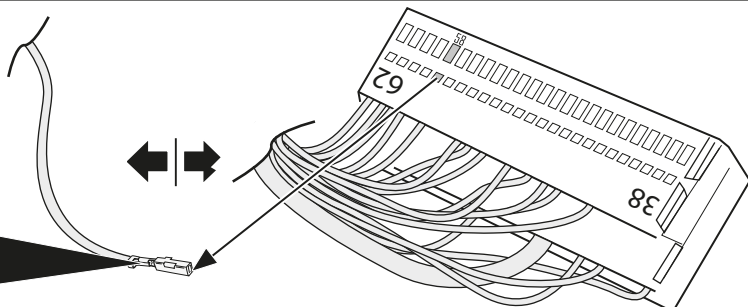

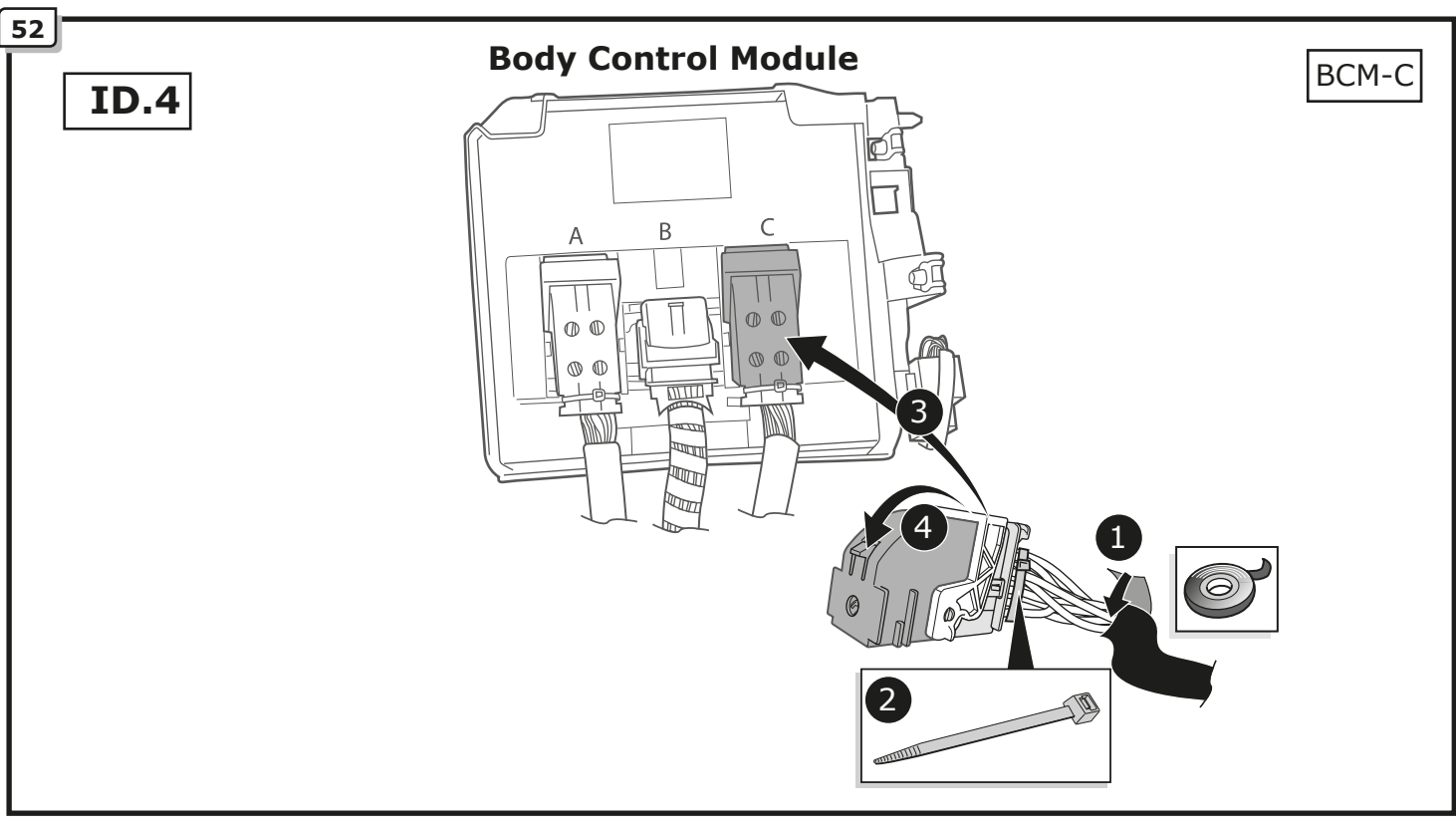
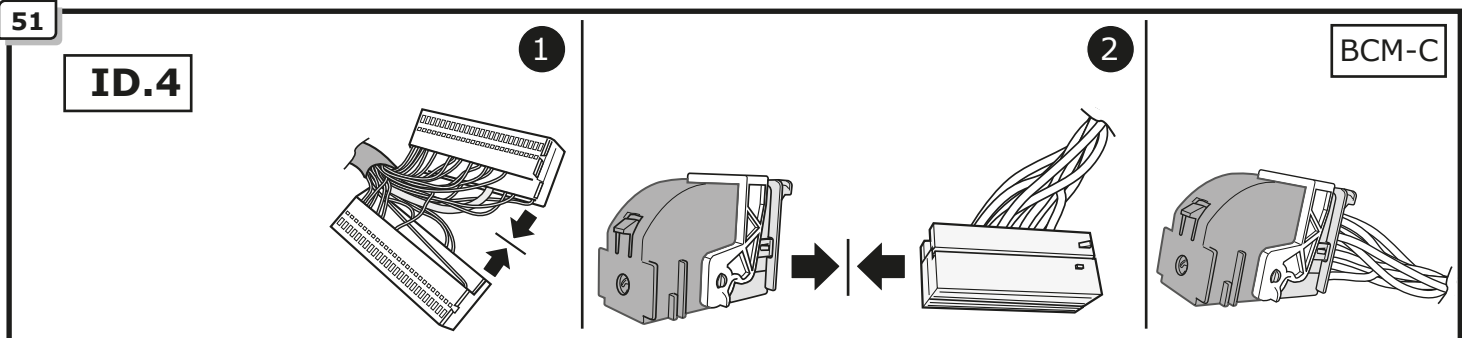
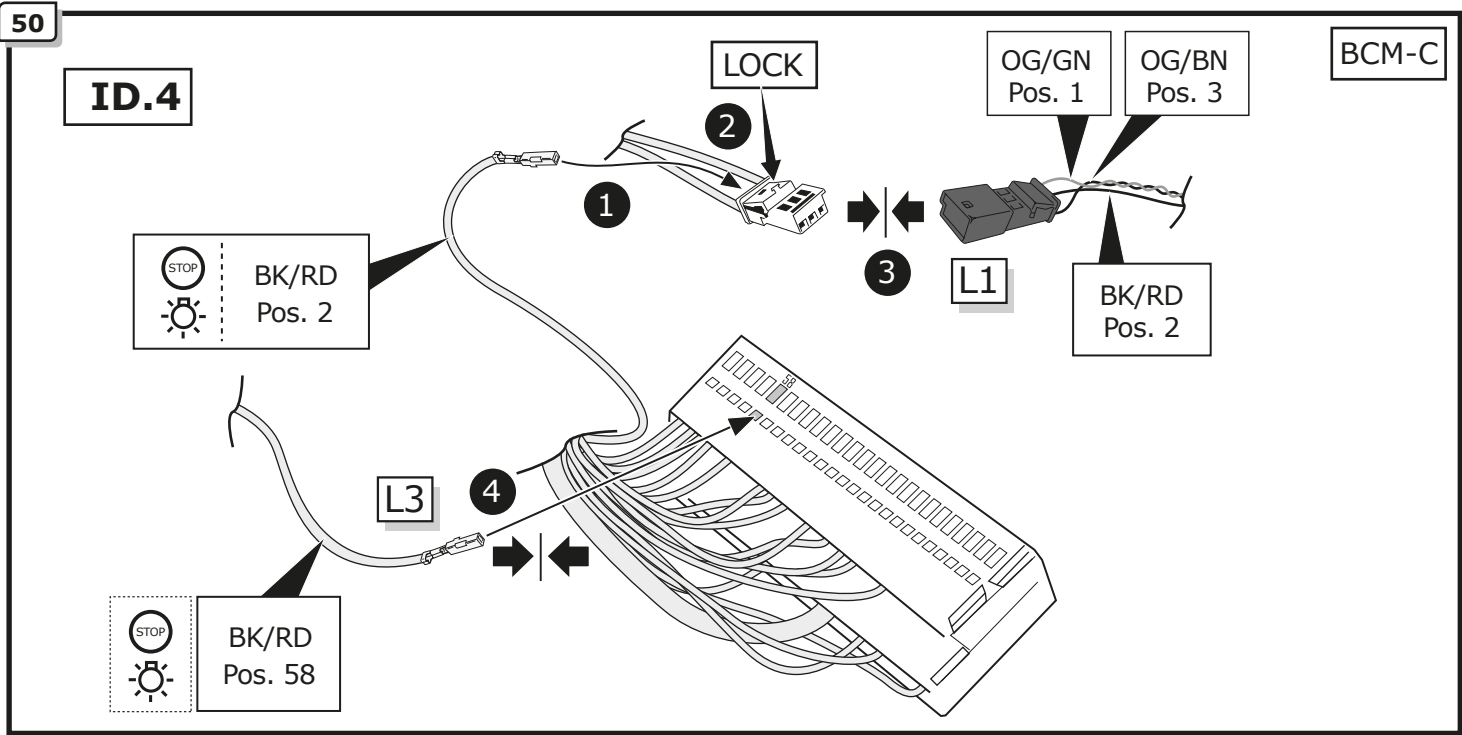

53

ID.4

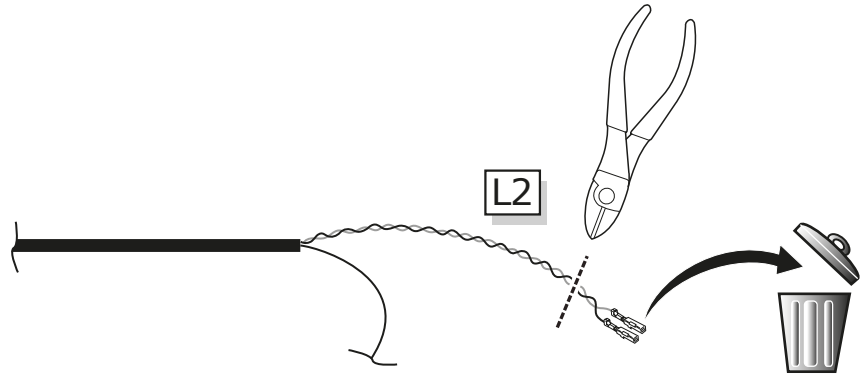

54

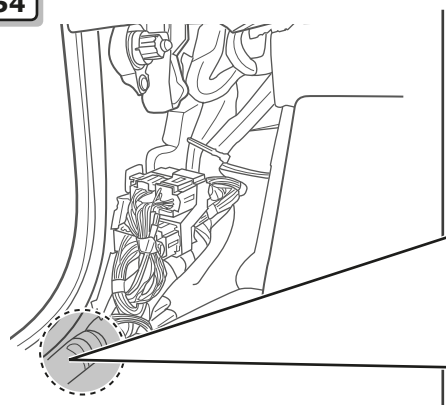

CAN-Data Wire

- OG/BN CAN low
- GN CAN high

ID.4

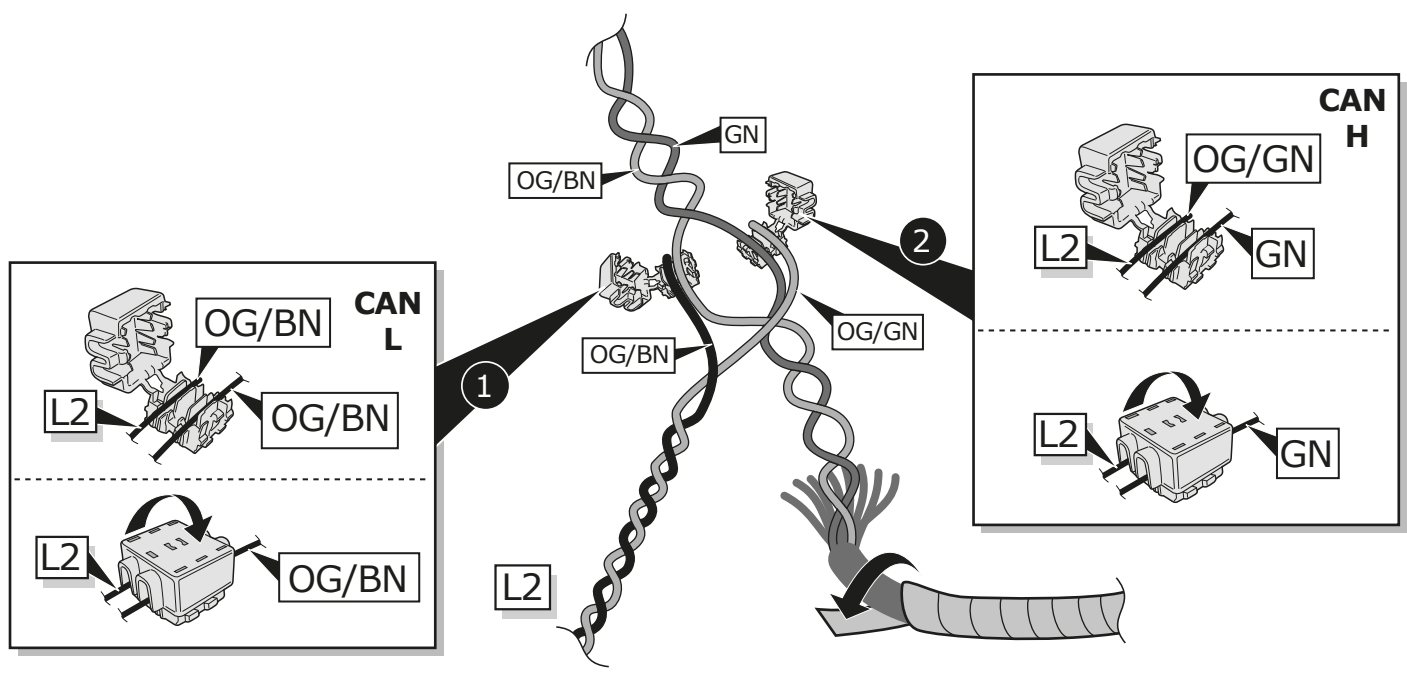

INFO



F1

RD/BU is for +30 Module



OG is for +30 Trailer



**B+/30
OPTION A**

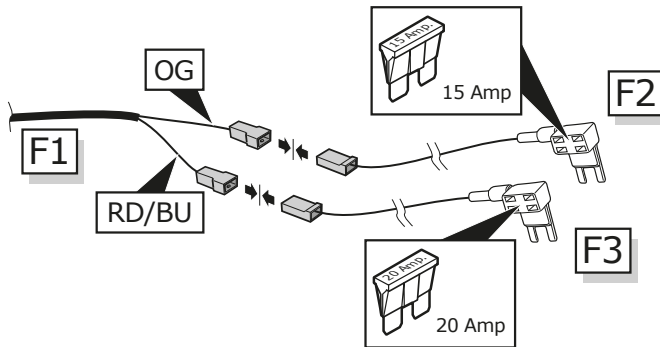

56

60 → 65

**B+/30
OPTION B**



57

→ 65

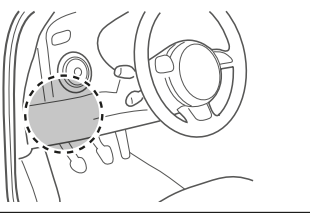

**B+/30
OPTION A**

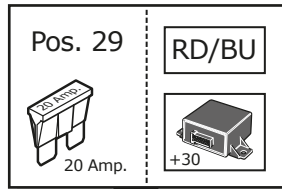

F1

F2

F3

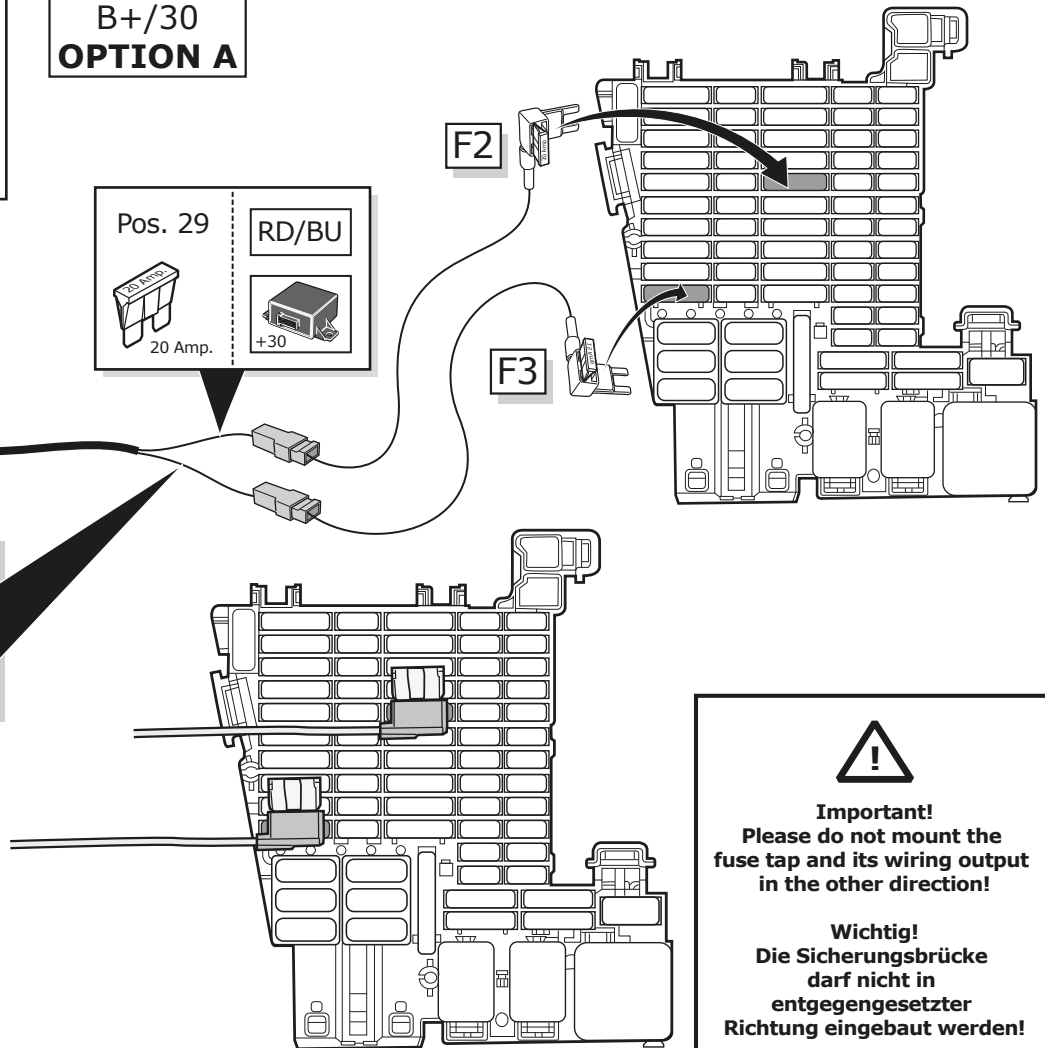
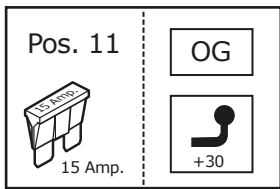

Important!
Please do not mount the fuse tap and its wiring output in the other direction!

Wichtig!
Die Sicherungsbrücke darf nicht in entgegengesetzter Richtung eingebaut werden!

57

B+/30
OPTION B

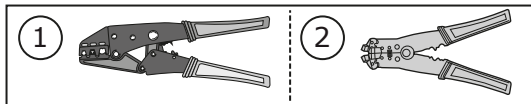
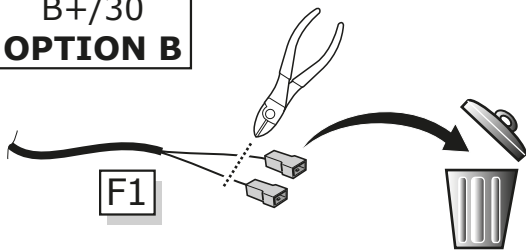

58

B+/30
OPTION B

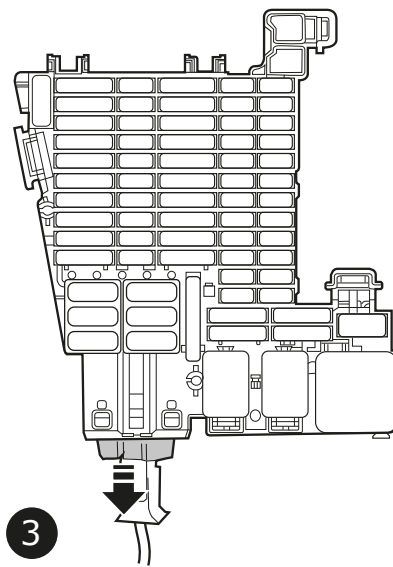
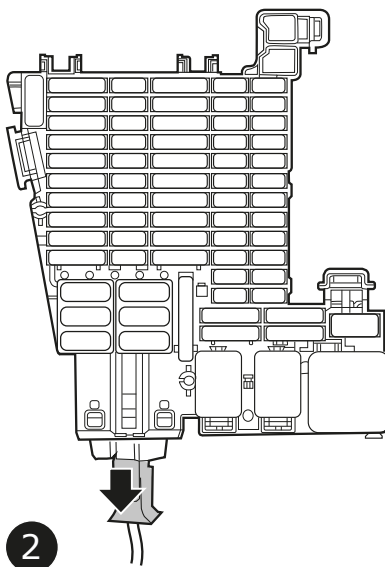
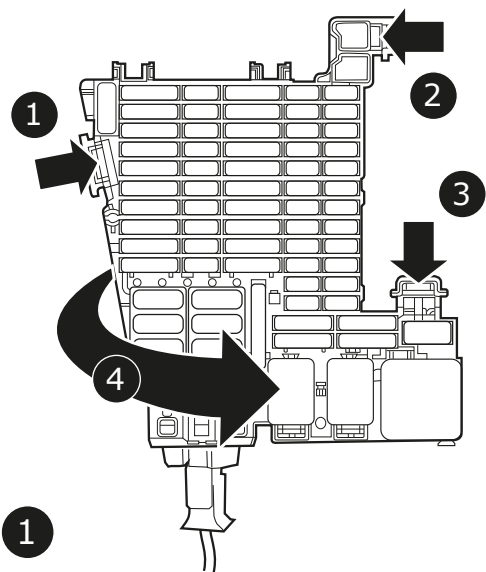

59

B+/30
OPTION B

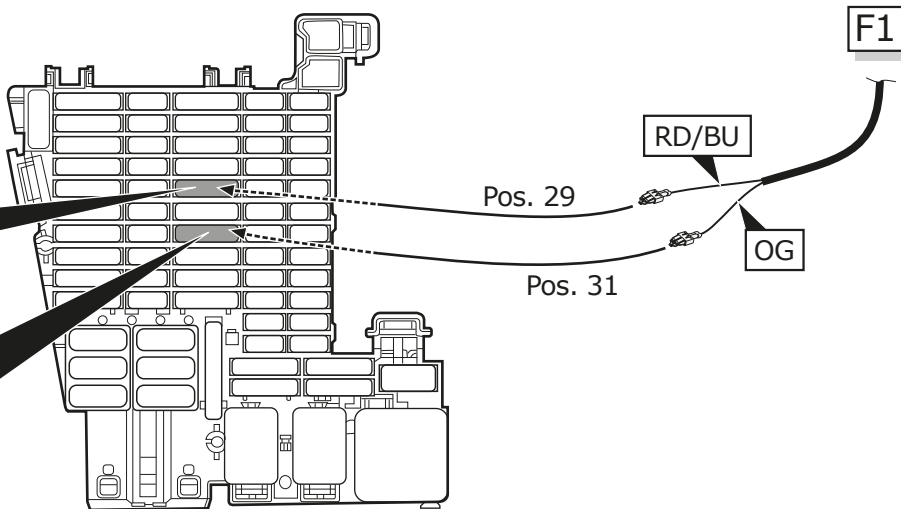
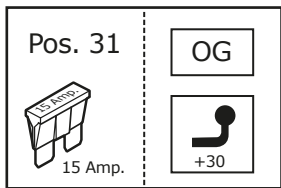
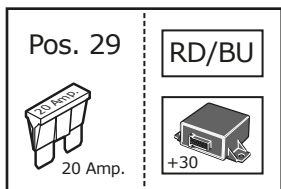

60

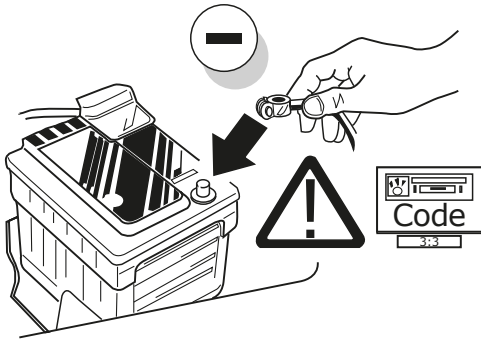

61

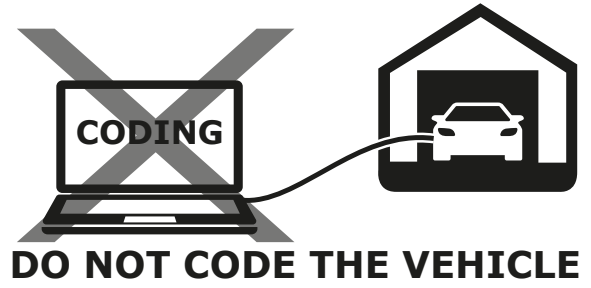

62

Functional test

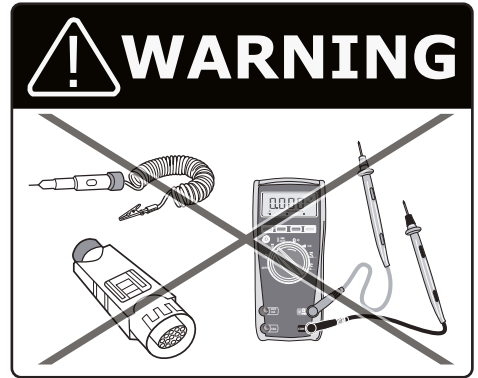
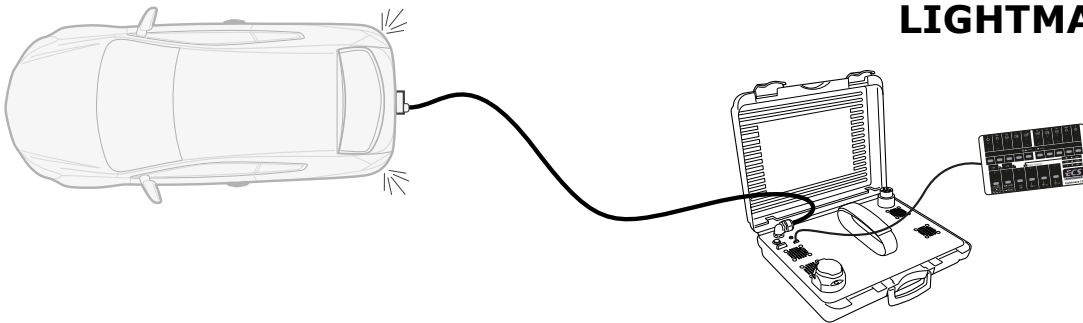
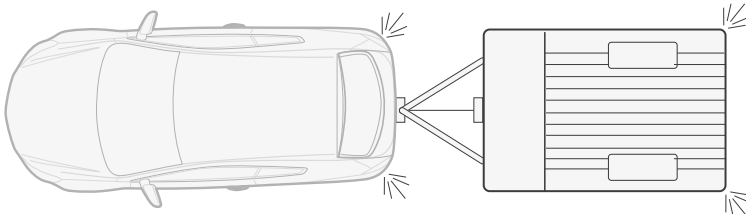
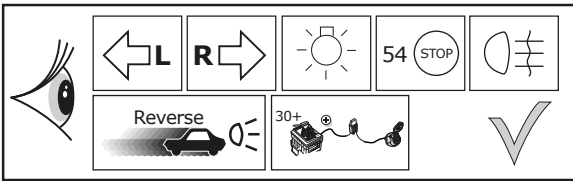

LIGHTMATE

ECS part no.
LIGHTMATE II
LIGHTMATE III

63

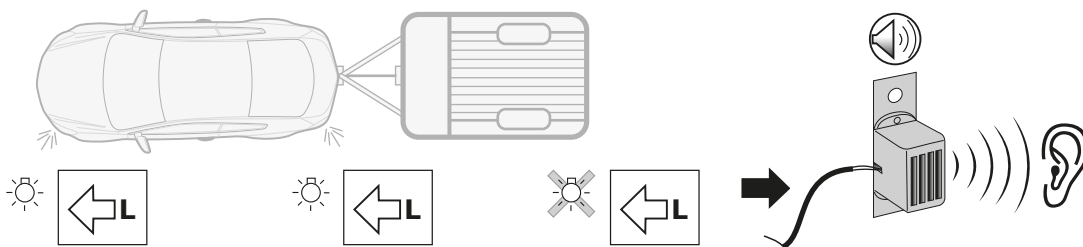
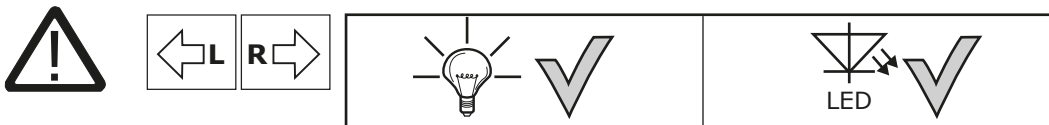



Rear fog light cut-off is not supported!



PDC to be deactivated manually!

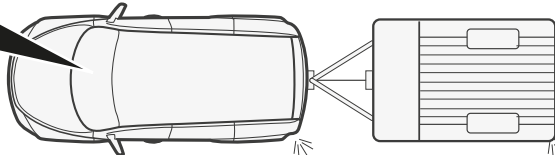
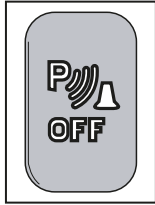

Folgende Beleuchtungsfunktionen des Anhängers werden **nicht** bei allen Zugfahrzeugen mit **Tagesfahrlichtschaltung** unterstützt:

DE

- Schlussleuchten
- Begrenzungsleuchten
- Kennzeichenbeleuchtung

Zur Aktivierung dieser Funktionen muss **Stand- oder Abblendlicht eingeschaltet** werden!

IT

Le seguenti funzioni per l'illuminazione del rimorchio **non sono supportate** da tutte le motrici **con circuito di luci diurne**:

- luci posteriori
- luci d'ingombro
- illuminazione targa

Per attivare queste funzioni devono essere accese **le luci di posizione o gli anabbaglianti!**

The following light functions for the trailer are **not supported** by all towing vehicles with **DRL circuit**:

GB

- Rear lights
- Side lights
- Numberplate lights

The **taillights or dimmed headlights must be switched on** to activate this function!

NL

De volgende verlichtingsfuncties van de aanhanger worden **niet** bij alle trekkende voertuigen met **daglichtschakeling** ondersteund:

- Achterlichten
- Spatbordlampen
- Kentekenverlichting

Ter activering van deze functies moet **parkeer- of dimlicht** worden ingeschakeld!

Les fonctions d'éclairage suivantes de la remorque **ne sont pas activables** sur tous les véhicules de traction équipés de **feux de circulation de jour**:

FR

- Feux arrières
- Feux d'encombrement
- Éclairage de la plaque minéralogique

Pour activer ces fonctions, **les feux de position ou de croisement** doivent être allumés!

ES

No todos los vehículos tractores **con conmutación de luz de marcha diurna** ofrecen un soporte para las siguientes funciones de iluminación del remolque:

- Luces traseras
- Luces de gálibo
- Iluminación de la matrícula

¡Para activar estas funciones deberán encenderse **las luces de posición o las luces de cruce!**

Optional

Adapter socket

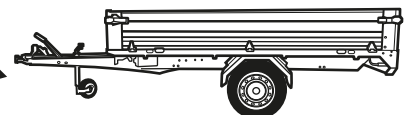
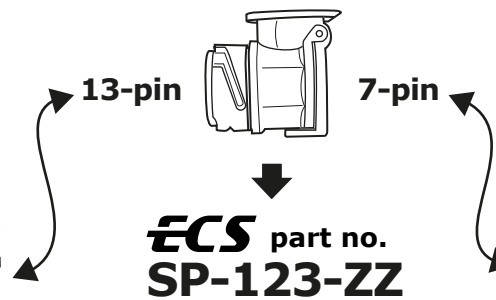
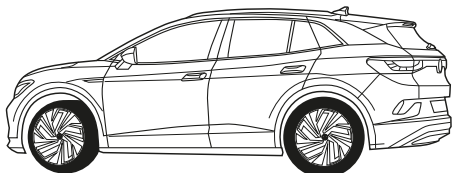

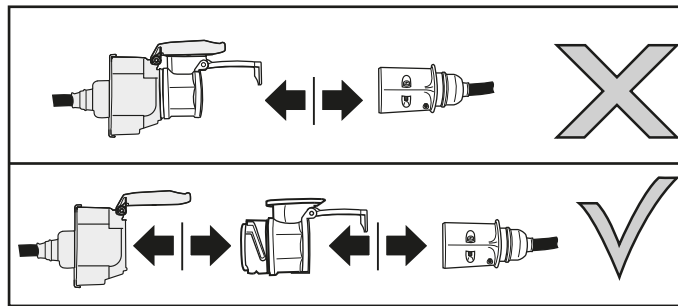
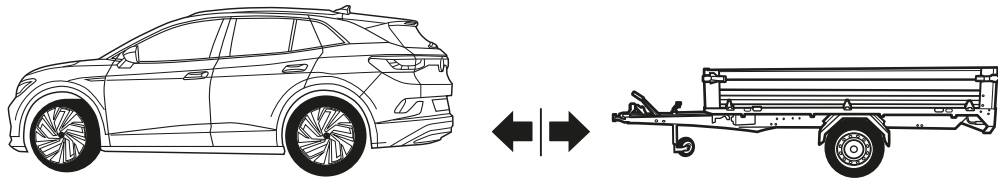

Products & Service: <https://www.ecs-electronics.nl/test-equipment>

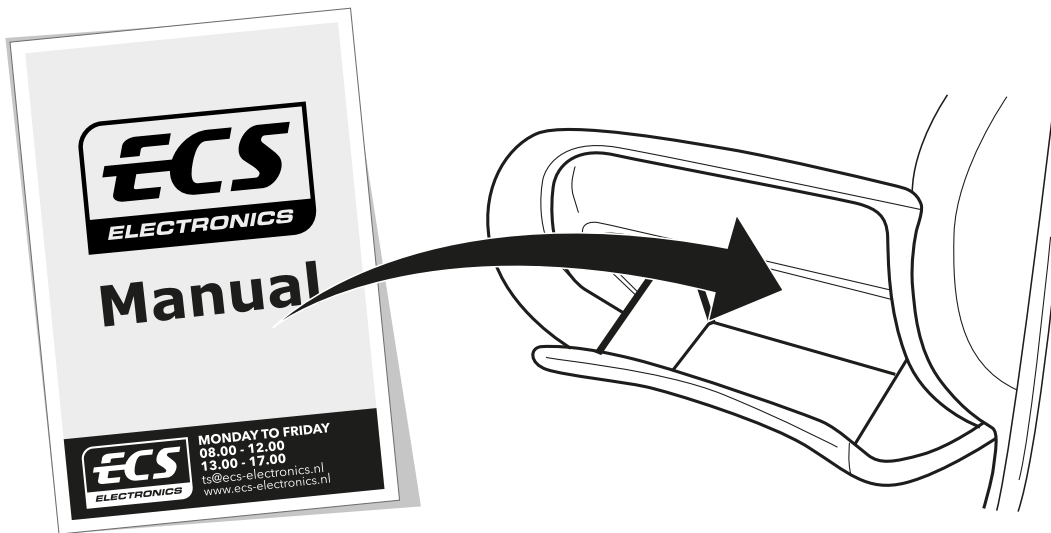
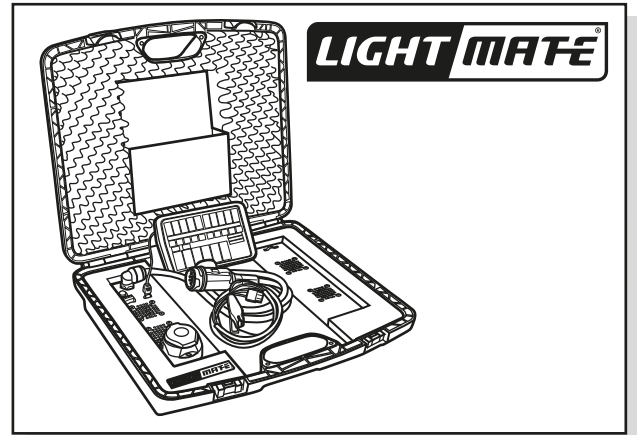
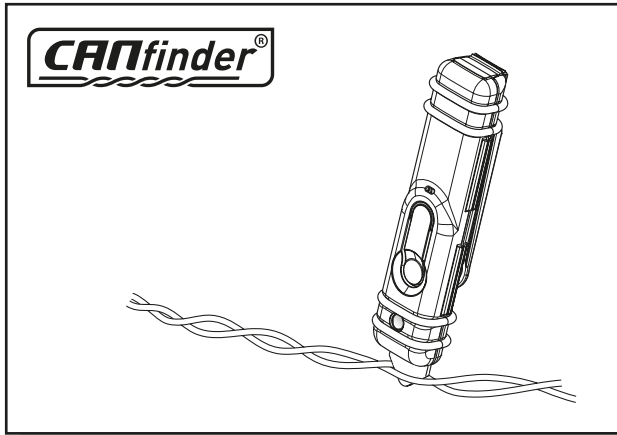

**FITTERS
TECHNICAL
SUPPORT**



**MONDAY TO FRIDAY
08.00 - 12.00
13.00 - 17.00**

ts@ecs-electronics.nl
www.ecs-electronics.nl
tel: +31 (0)76 573 0020

INFO

- (DE) Anschluss Steckdose (ES) Conexión de la caja de enchufe (CZ) Objímkový konektor (GR) Υποδοχή σύνδεσης
- (FR) Connection de la prise (IT) Allaccio zoccolo (DK) Stikdåse forbindelse (NO) Tilkobling koblingsboks
- (NL) Contactdoos aansluiting (SE) Anslutning kontaktdosa (FI) Pistorasia liitäntä (PL) Połączenie przez gniazdo
- (GB) Socket connection

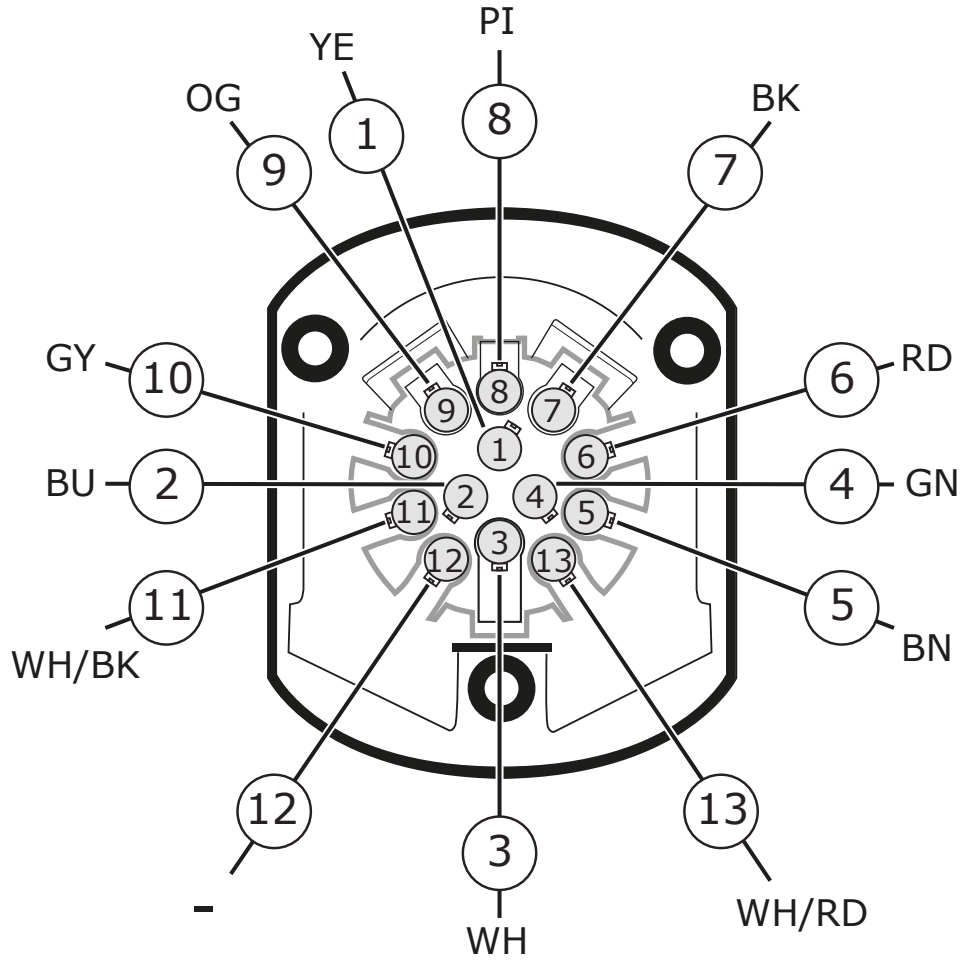
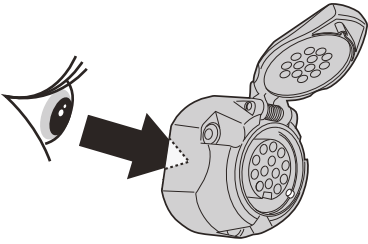

- (DE) Anschluss Steckdose (ES) Conexión de la caja de enchufe (CZ) Objímkový konektor (GR) Υποδοχή σύνδεσης
- (FR) Connection de la prise (IT) Allaccio zoccolo (DK) Stikdåse forbindelse (NO) Tilkobling koblingsboks
- (NL) Contactdoos aansluiting (SE) Anslutning kontaktdosa (FI) Pistorasia liitäntä (PL) Połączenie przez gniazdo
- (GB) Socket connection

DIN/ISO 11446													
Pmax	21W	21W		21W	42W	3x21W	42W	21W	180W/10Amp	OPTION			
	YE	BU	WH	GN	BN	RD	BK	PI	OG	GY	WH/BK	-	WH/RD

COLORTABLE

	BK	BN	BU	GY	GN	WH	YE	OG	PE	PI	RD
(DE)	Schwarz	Braun	Blau	Grau	Grün	Weiß	Gelb	Orange	Violett	Rosa	Rot
(FR)	Noir	Marron	Blue	Gris	Vert	Blanc	Jaune	Orange	Violet	Rose	Rouge
(NL)	Zwart	Bruin	Blauw	Grijs	Groen	Wit	Geel	Oranje	Paars	Roze	Rood
(GB)	Black	Brown	Blue	Grey	Green	White	Yellow	Orange	Purple	Pink	Red
(ES)	Negro	Marrón	Azul	Gris	Verde	Blanco	Amarillo	Naranja	Morado	Rosa	Rojo
(IT)	Nero	Marrone	Blu	Grigio	Verde	Bianco	Giallo	Arancione	Viola	Rosa	Rosso
(SE)	Svart	Brun	Blå	Grå	Grön	Vit	Gul	Orange	Lila	Rosa	Röd
(CZ)	Černá	Hnědá	Modrá	Šedá	Zelená	Bílá	Žlutá	Oranžová	Fialová	Růžová	Červená
(DK)	Sort	Brun	Blå	Grå	Grøn	Hvid	Gul	Orange	Lilla	Pink	Rød
(FI)	Musta	Ruskea	Sininen	Harmaa	Vihreä	Valkoinen	Keltainen	Oranssi	Purppura	Vaaleanpunainen	Punainen
(GR)	Μαύρο	Καφέ	Μπλε	Γκρι	Πράσινο	Λευκό	Κίτρινο	Πορτοκαλί	Μοβ	Ροζ	Κόκκινο
(NO)	Svart	Brun	Blå	Grå	Grønn	Hvit	Gul	Oransje	Lilla	Rosa	Rød
(PL)	Czarny	Brazowy	Niebieski	Szary	Zielony	Biały	Żółty	Pomarańczowy	Purpurowy	Różowy	Czerwony