

Citroën Jumper Van & Chassis-Cab 01/2011 >>
Fiat Ducato Van & Chassis-Cab 01/2011 >> 06/2021
Opel Movano C Van & Chassis-Cab 01/2022 >>
Peugeot Boxer Van & Chassis-Cab 01/2011 >>

Partnr.: FI-050-HX

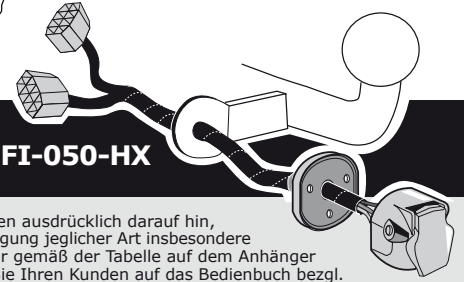

DE

• Einbauanleitung Elektrosatz Anhängervorrichtung mit 13-P Steckdose lt. DIN/ISO Norm 11446. • Wir weisen ausdrücklich darauf hin, dass eine unsachgemäße und nicht in einer Fachwerkstatt durchgeführte Montage einen Verzicht auf Entschädigung jeglicher Art insbesondere bezüglich des Produkthaftpflichtrechts zur Folge hat. • Technische Änderungen vorbehalten. • Widerstand nur gemäß der Tabelle auf dem Anhänger verwenden. • Achtung! Bitte lesen Sie vorab diese Anleitung, nehmen Sie diese zur Kenntnis und verweisen Sie Ihren Kunden auf das Bedienbuch bezgl. der eventuell zu treffenden Maßnahmen zum Ziehen eines Anhängers. • Bei Funktionsproblemen ist die Fehlersuche auf ca. 0,5 Stunden zu begrenzen, kontaktieren Sie die ECS Technical Support: ts@ecs-electronics.nl / 00800 22552327

FR

• Instructions de montage du faisceau électrique pour crochet d'attelage conforme à la norme DIN/ISO 11446 prise 13-P. • Il est expressément prévu qu' on ne saurait se prévaloir d'un quelconque préjudice contractuel ou réhibitoire si le montage avait été fait en dépit des dites instructions ou dans un garage ne disposant pas des équipements adéquats. • Sous réserve de modifications techniques. • Ne excédez pas la charge maximale, indiquée dans le tableau. • Attention! Avant de commencer le branchement, on vous prie de prendre compte des connexions à faire dans la notice, ainsi que communiquer directement à votre client les mesures à prendre pour tirer une remorque. • S'il y a des problèmes de fonctionnement, limiter la recherche de défauts à env. 30 minutes et contacter ECS l'Aide en ligne: ts@ecs-electronics.nl / 00800 22 55 23 27.

NL

• Montage-handleiding elektrokabelset voor trekhaak met 13-P contactdoos vlg. DIN/ISO norm 11446. • Wij wijzen er met nadruk op, dat ondeskundige en niet door een vakkundige werkplaats uitgevoerde montage tot gevolg heeft dat daardoor ieder recht op schadevergoeding, ook op wettelijke aansprakelijkheid inzake producten, vervalt. • Technische wijzigingen voorbehouden. • Gebruik alleen belasting volgens aansluittabel op het getrokken voertuig. • Opgelet! Wij verzoeken U dringend vooraf deze instructie door te nemen, hiervan kennis te nemen en uw cliënt te verwijzen naar het instructieboekje betreffende de eventueel te nemen maatregelen voor het trekken van een aanhangwagen. • Bij werkingsproblemen moet de foutencontrole tot ca. 0,5 uur beperkt worden, neem contact op met de ECS Technical Support: ts@ecs-electronics.nl / 00800 22 55 23 27.

GB

• Fitting instructions electric wiring kit tow bar with 13-P socket up to DIN/ISO Norm 11446. • We would expressly point out that assembly not carried out properly by a competent installer will result in cancellation of any right to damage compensation, in particular those arising by virtue of the product liability act. • Contents of these kits and their fitting manuals are subject to alteration without notice, please ensure that these instructions are read and fully understood before commencing installation. • Do not overload circuits; the maximum loads per connection are detailed in this manual. • Attention! Before Installation, please read this manual carefully and inform your customer to consult the vehicle owners manual to check for any vehicle modifications required before towing. • In the event of functional problems, troubleshooting must be limited to about 0.5 hours, contact the ECS Technical Support: ts@ecs-electronics.nl / 00800 22 55 23 27.

ES

• Instrucciones de montaje de kit eléctrico para enganche de remolque con caja de conexiones 13-P según norma DIN/ISO 11446. • El montaje inapropiado y efectuado por personal no cualificado originará la pérdida de todo derecho a indemnización o la expiración de toda responsabilidad civil con respecto al producto. • Nos reservamos el derecho a efectuar modificaciones técnicas. • Utilice sólo cargas de acuerdo a la tabla de conexión del vehículo remolcado. • Atención: lea atentamente este manual antes de la instalación e informe al cliente que debe consultar el manual de usuario del vehículo para conocer cualquier modificación realizada. • En caso de tener problemas con su funcionamiento, la búsqueda de errores está limitada a aprox. 0,5 horas, por lo que le recomendamos ponerse en contacto con el servicio de atención telefónica: ts@ecs-electronics.nl / 00800 22 55 23 27.

IT

• Istruzioni di montaggio di set di cavi elettrici per gancio da traino con zoccolo a 13-P conforme alla norma DIN/ISO 11446. • Sottolineiamo espressamente che un montaggio inadeguato ed eseguito da un'officina non specializzata ha come conseguenza il decadere di qualsiasi diritto al risarcimento danni, nonché alla responsabilità legale relativa ai prodotti. • Ci si riserva il diritto di apportare modifiche tecniche. • Utilizzare esclusivamente un carico conforme alla tabella degli allacci relativa al veicolo in questione. • Attenzione! Vi invitiamo a leggere attentamente questo manuale e a invitare a vostra volta i clienti a leggere il manuale del conducente sulle eventuali misure da prendere per l'attacco di un rimorchio. • In caso di problemi di funzionamento, la ricerca di errori dovrebbe essere limitata a circa 0,5 ore. Contattare il centralino di assistenza per i fasci di cavi: ts@ecs-electronics.nl / 00800 22 55 23 27.

SE

• Monteringsanvisningar elkabelsats för dragkrok med 13-P kontaktdosa enligt DIN/ISO norm 11446. • Vi påpekar med eftertryck att all rätt till skadeersättning och all laglig ansvarighet förfaller om monteringen inte har utförts på rätt sätt och av en professionell verkstad. • Tekniska ändringar förbehålles. • Använd endast belastning enligt anslutningstabellen på det dragna fordonet. • Varning! Innan installation, läs den här handboken noga och informera din kund om att läsa fordonets användarhandbok för att undersöka vilka eventuella ändringar som behöver göras på fordonet. • Vid funtionsproblem ska felsökningen begränsas till ca 0,5 timme, kontakta reservdels-helpline ts@ecs-electronics.nl / 00800 22 55 23 27.

CZ

• Montážní pokyny: souprava pro elektrické propojení tažné tyče s 13-P zásuvkou do normy DIN/ISO 11446. • Výslovně zdůrazňujeme, že jakákoli montáž, která není provedená ve specializované dílně, má za následek odvolání nároků na kompenzaci jakéhokoli druhu, obzvláště vyplývajících ze zákona o odpovědnosti za způsobené škody. • Změny mohou být provedeny bez oznámení. • Používejte pouze při maximálním nabití podle tabulky na tažném vozidle. • Upozornění! Prosíme, abyste si nejdříve přečetli tyto instrukce, seznámili se s nimi a odkázali své zákazníky na příručku týkající se případných opatření, která musí být přijata pro tažení přívěsu. • Při problémech funkčnosti je třeba vyhledávání chyb omezit na cca 0,5 hodiny, kontaktujte ECS Technical Support: ts@ecs-electronics.nl / 00800 22 55 23 27.

DK

• Monteringsvejledninger for det elektriske ledningsføringssæt for trækstang med 13-P stikdåse, DIN/ISO, norm 11446. • Vi ønsker at gøre udtrykkeligt opmærksom på atforkert samling, der ikke er udført af et specialiseret værksted, resulterer i bortfaldelse af kompenseringsskrav af alle slags, i særdeles krav der måtte opstå omkring det lovligtige ansvar. • Kan ændres uden varsel. • Brug kun den maksimale belastning, i overensstemmelse med forbindelsestabelen for bugserede køretøjer. • OBS! For installation skal denne vejledning læses omhyggeligt og din kunde skal informeres om at kigge i køretøjets håndbog for at kontrollere om der skal laves eventuelle ændringer på køretøjet inden bugsering. • Ved funktionsproblemer skal fejlsøgningen begrænses til ca. 0,5 time, kontakt ECS Technical Support: ts@ecs-electronics.nl / 00800 22 55 23 27.

FI

• Ohjeet vetokoukun sähkökaapelisarjan asentamiseen, jossa on DIN/ISO 11446 mukainen 13-P liitin. • Korostamme, että kaikki oikeudet vahinkokorvaukseen kuten myös valmistajan laillinen vastuu raukeavat, mikäli asennusta ei ole toteutettu oikealla tavalla eikä ammattitaitoisen asiantuntijan toimesta. • Oikeus teknisiin muutoksiin ilman erillistä huomautusta pidätetään. • Huomio! Lue tämä käyttöopas huolellisesti ennen asennusta ja tiedota asiakkaita tarkistamaan kaikki ajoneuvon muutoksen ajoneuvon omistajan käyttöoppaas ennen hinausta. • Kuormita työvirtapiiriä ainoastaan hinattavan ajoneuvon kytkentäkaavin mukaisesti. • Virhehaku on rajoitettava toiminto-ongelmien esiintyessä noin 0,5 tuntiin, ota yhteys ECS Technical Support: ts@ecs-electronics.nl / 00800 22 55 23 27.

GR

• Οδηγίες συναρμολόγησης ηλεκτρικού σετ καλωδίων μπάρας ρυμούλκησης με υποδοχή 13-P μέχρι DIN/ISO Κανόνας 11446. • Επισημαίνουμε κατηγορηματικά ότι οποιαδήποτε ασφαλή συναρμολόγηση, η οποία δεν έχει πραγματοποιηθεί ειδικό εργαστήριο θα οδηγήσει σε αποποίηση των αξιώσεων επιβολής αποζημιώσεων οποιοδήποτε είδους, ειδικά όσα προκύπτουν από το νόμο ευθύνης προϊόντων. • Μπορεί να τροποποιηθεί χωρίς προηγούμενη ειδοποίηση. • Χρησιμοποιείτε μόνο μέγιστο ηλεκτρικό φορτίο σύμφωνα με τον πίνακα σύνδεσης στο ρυμούλκούμενο όχημα. • Προσοχή! Πριν την εγκατάσταση, διαβάστε το χειρίδιο αυτό προσεκτικά και ενημερώστε τον πελάτη σας να συμβουλευτεί το χειρίδιο ιδιοκτητήτων οχήματος ώστε να ελεγχθεί τυχόν τροποποιήσεις που απαιτούνται στο όχημα πριν τη ρυμούλκηση. • Σε περίπτωση προβλημάτων λειτουργίας να περιοριστεί η αναζήτηση ασφαλήτων σε περί. 0,5 δευτ., επικοινωνήστε με τη γραμμή υποστήριξης ECS Technical Support: ts@ecs-electronics.nl / 00800 22 55 23 27.

NO

• Monteringsanviser elkabelsett for trekkrok med 13-P koblingsboks ifølge DIN/ISO norm 11446. • Vi påpeker ettertrykkelig at all rett til skadeerstatning og rettslig ansvar forfaller dersom monteringen ikke er blitt utført på riktig måte og av et profesjonelt verksted. • Tekniske endringer forbeholdes. • Overskrid ikke grensene anviset i tilkoblingstabellen på tilhengeren eller det tilkoblede kjøretøyet. • OBS! Les denne bruksanvisningen nøye før installasjon. Be kunden om å rådføre seg med brukerhåndboken for kjøretøyeiere for å sjekke om kjøretøyet må modifiseres før tauing. • Ved funksjonsproblemer må feilsøket begrenses til ca. 0,5 timer, kontakt ECS Technical Support: ts@ecs-electronics.nl / 00800 22 55 23 27.

PL

• Instrukcje montażu zestawu okablowania elektrycznego dysza holowniczego z 13-P stykowym gniazdem DIN/ISO 11446. • Chcielibyśmy wyraźnie zaznaczyć, iż wszelki nieprawidłowy montaż, który nie jest wykonywany w specjalistycznym warsztacie pociąga za sobą utratę możliwości dochodzenia wszelkiego typu roszczeń, w szczególności tych wynikających z odpowiedzialności producenta za swój produkt. • Podlega zmianom bez powiadomienia. • Używać tylko takiego maksymalnego obciążenia które wynika z tabliczki połączeń holowanego pojazdu. • Uwaga! Przed zainstalowaniem należy dokładnie przeczytać tę instrukcję i poinformować klienta o konieczności sprawdzenia w instrukcji posiadacza pojazdu w celu sprawdzenia przed holowaniem, czy nie wprowadzono do pojazdu jakichkolwiek zmian. • W przypadku problemów ograniczyć wyszukiwanie błędów do ok. 0,5 godziny, skontaktować się z linią serwisową ts@ecs-electronics.nl / 00800 22 55 23 27.

Einzelteilliste

Liste de pieces

Onderdelenlijst

Part list

Lista de componentes

Elenco componenti

Dellista

Seznam dílů

Del-liste

Osaluettelo

Κατάλογος εξαρτημάτων

Delliste

Lista części

DE

FR

NL

GB

ES

IT

SE

CZ

DK

FI

GR

NO

PL

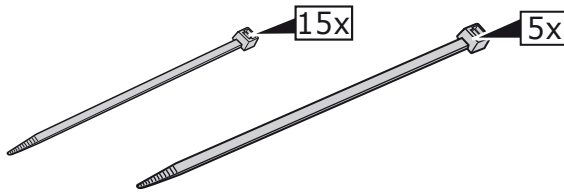
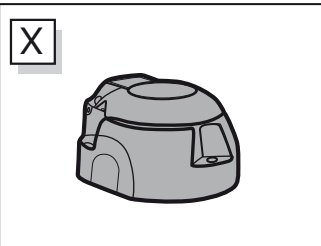
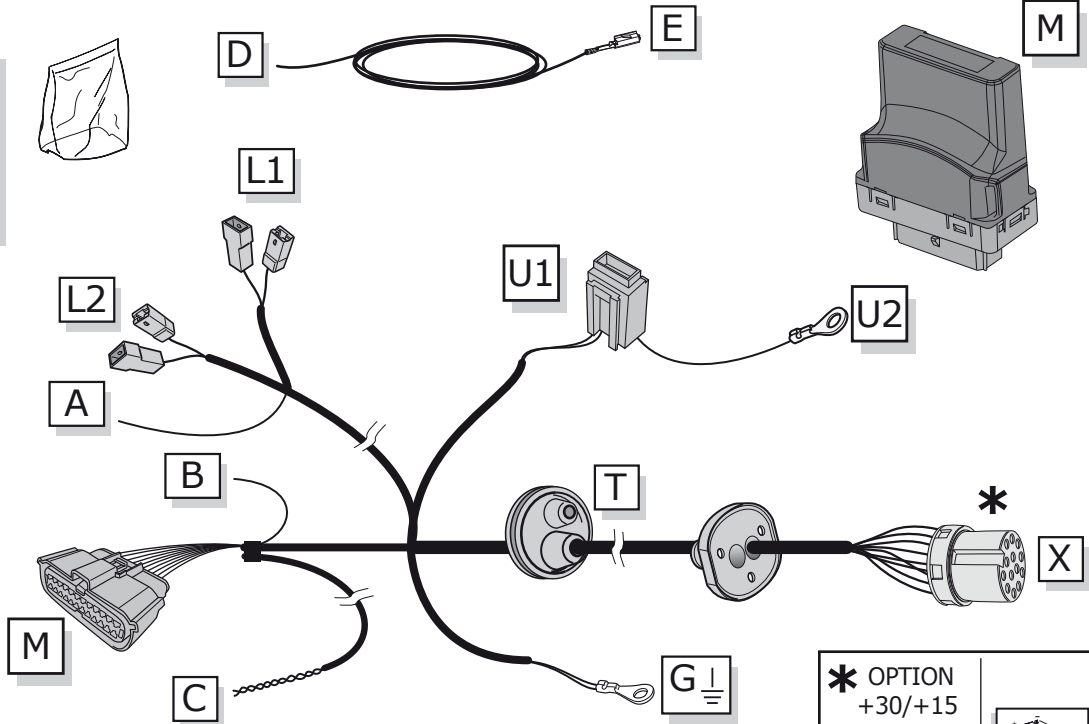

*** OPTION
+30/+15
FI050ZZ**

vorbereitung für
préparation pour
voorbereiding voor
preparación para
preparazione per
förberedelse för
příprava pro
förberedelse for
Προετοιμασία για
förberedelse på
przygotowanie do

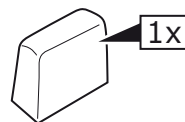
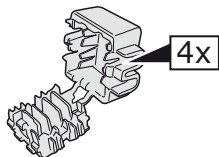
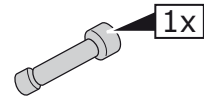
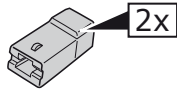
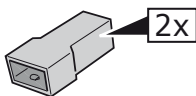
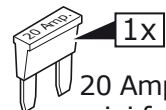
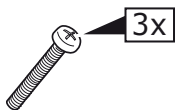
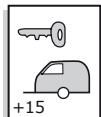
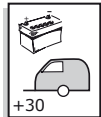

INFO

	BK	BN	BU	GY	GN	WH	YE	OG	PE	PI	RD
(DE)	Schwarz	Braun	Blau	Grau	Grün	Weiß	Gelb	Orange	Violett	Rosa	Rot
(FR)	Noir	Marron	Bleu	Gris	Vert	Blanc	Jaune	Orange	Violet	PI	Rouge
(NL)	Zwart	Bruin	Blauw	Grijs	Groen	Wit	Geel	Oranje	Paars	Roze	Rood
(GB)	Black	Brown	Blue	Grey	Green	White	Yellow	Orange	Purple	Pink	Red
(ES)	Negro	Marrón	Azul	Gris	Verde	Blanco	Amarillo	Naranja	Morado	Rosa	Rojo
(IT)	Nero	Marrone	Blui	Grigio	Verde	Bianco	Giallo	Arancione	Viola	Rosa	Rosso

ROUTING

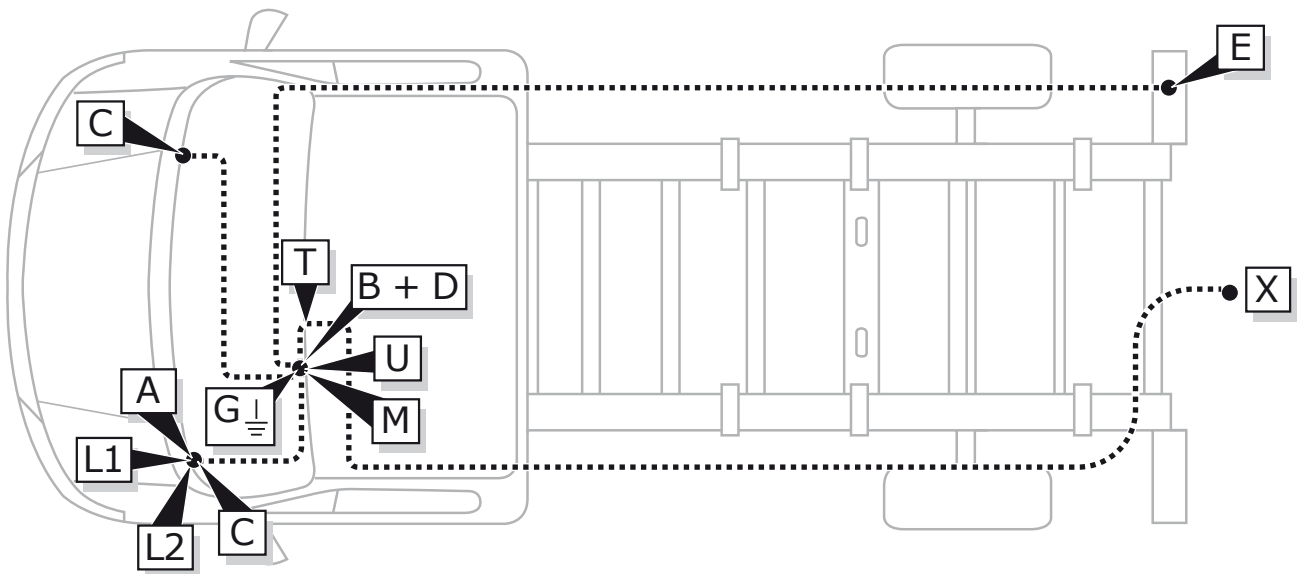

1

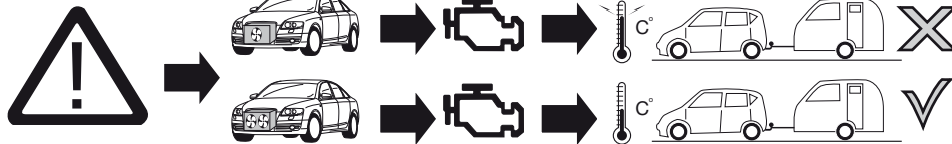
**ACHTUNG!**

(DE)

Die Kühlerleistung des Fahrzeuges muß bei Nachrüstung einer Anhängerkupplung möglicherweise erhöht werden! Bitte unbedingt Herstellerangaben beachten!!

ATTENTION!

(FR)

Il peut s'avérer nécessaire d'augmenter la puissance du radiateur du véhicule lorsque celui est équipé ultérieurement d'un attelage remorque! Respecter impérativement les instructions du constructeur!!

ATTENTIE!

(NL)

Het koelvermogen van het voertuig moet mogelijk worden verhoogd als achteraf een aanhangerkoppeling wordt aangebracht! Absoluut de fabriekspgaven in acht nemen a.u.b.!!

ATTENTION!

(GB)

The vehicle's cooling capacity may have to be increased when retrofitting a trailer coupling! You must observe the manufacturer's instructions!!

¡ATENCIÓN!

(ES)

¡Es posible que haya que aumentar la capacidad del radiador en caso de reequipar un acoplamiento de remolque! ¡Rogamos tener en cuenta las instrucciones de fabricante sin falta!

ATTENZIONE!

(IT)

La capacità di raffreddamento del veicolo, quando si applica un gancio di traino, si deve possibilmente aumentare! Si prega di osservare tassativamente le indicazioni del produttore!!

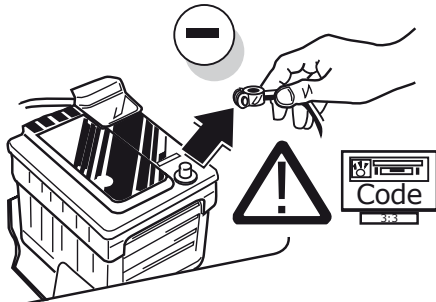

(DE)

Um Störungen und Schäden am Bordnetz zu vermeiden, muss die Massepolklemme unbedingt vor Beginn aller Arbeiten von der Fahrzeugbatterie getrennt werden! Insbesondere bei Arbeiten und Anschlüssen am CAN-Datenbus kann bei nicht abgeklemmter Batterie sowohl das Anhängermodul als auch das fahrzeugseitige Bordnetzsteuergerät beschädigt werden! Bitte Herstellervorschriften beim Ab- und Anklebmen der Fahrzeugbatterie beachten!

(FR)

Afin d'éviter tout dys-fonctionnement ou endom-magement du circuit de bord, il est indispensable de débrancher la pince de masse de la batterie du véhicule avant le début de toute opération! En particulier s'il s'agit de travaux et de branchements effectués sur le bus de données CAN, si la batterie n'est pas débranchée, le module remorque aussi bien que le dispositif de commande de circuit de bord du véhicule risquent d'être endommagés! Veuillez respecter les directives du fabricant lors du branchement et du débranchement de la batterie du véhicule!

(NL)

Om storingen en schade aan de elektrische bedrading te vermijden moet de massapoolklem absoluut vóór aanvang van alle werkzaamheden worden losgekoppeld van de voertuigaccu! Vooral bij werkzaamheden aan en aansluitingen op de CAN-databus kan zowel de aanhangermodule als de voertuigzijdige regeleenheid voor de elektrische installatie beschadigd worden, als de accu niet ontkoppeld is! Fabrieksvoorschriften bij het vast- en loskoppelen van de voertuigaccu in acht nemen a.u.b.!

(GB)

In order to avoid mal-functions and damage to the vehicle's electrical system the earth terminal must be disconnected from the vehicle's battery before starting work! Both the trailer module and the vehicle's control unit for the electrical system can be damaged during work on the CAN data bus connections if the battery is not disconnected! Please pay attention to the manufacturer's instructions when disconnecting and reconnecting the vehicle's battery!

(ES)

¡Para evitar fallos y defectos en el sistema eléctrico de a bordo es imprescindible separar al terminal de puesta a tierra de la batería del vehículo antes de realizar cualquier trabajo! ¡Particularmente al realizar trabajos y conexiones al bus de datos CAN puede estropearse tanto el módulo para remolques como el regulador del sistema eléctrico de a bordo del vehículo si no se ha desconectado la batería! ¡Rogamos observar las instrucciones del fabricante al conectar y desconectar la batería del vehículo!

(IT)

Per evitare disturbi e danni alla rete di distribuzione elettrica, l'espansione polare a massa deve essere assolutamente scollegata dalla batteria del veicolo prima dell'inizio dei lavori! In particolare durante i lavori e gli allacciamenti al bus di dati CAN, se la batteria non è scollegata si possono danneggiare sia la centralina rimorchio, sia la centralina della rete di distribuzione elettrica del veicolo! Attenersi alle indicazioni del costruttore per scollegare e ricollegare la batteria del veicolo!

2

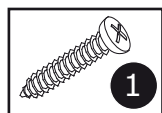
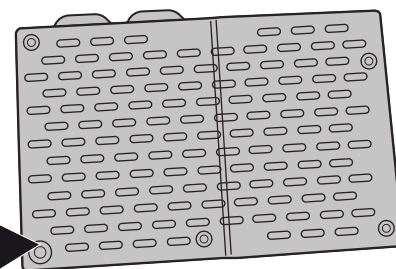
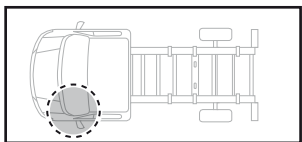

1

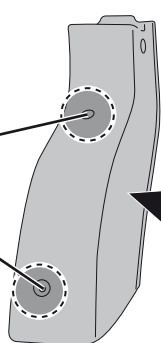

2

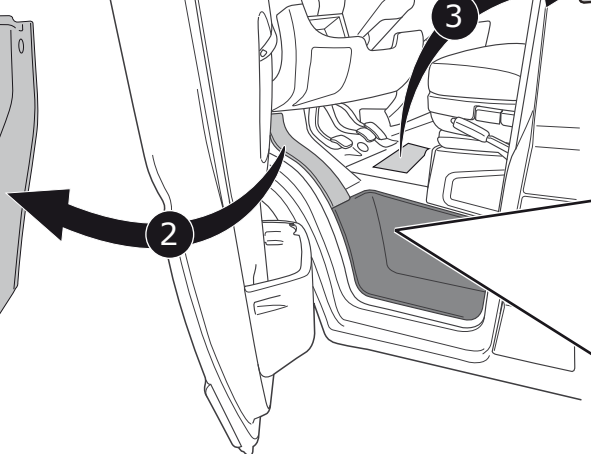

3

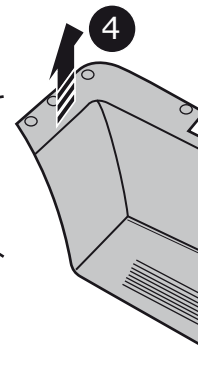

4

3

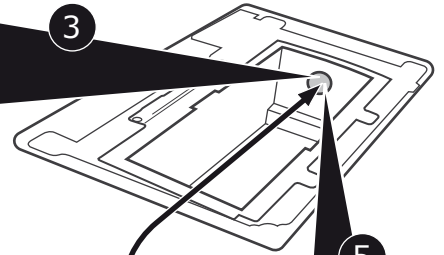
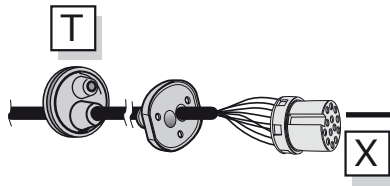
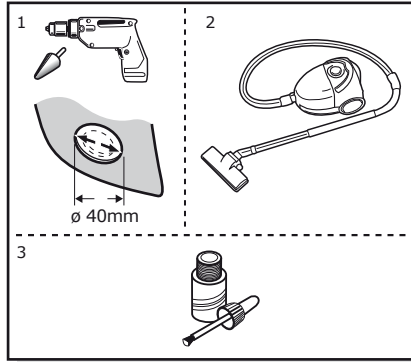
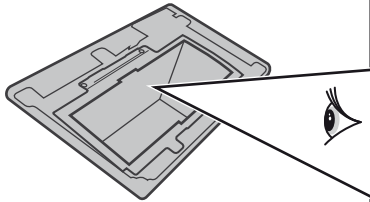
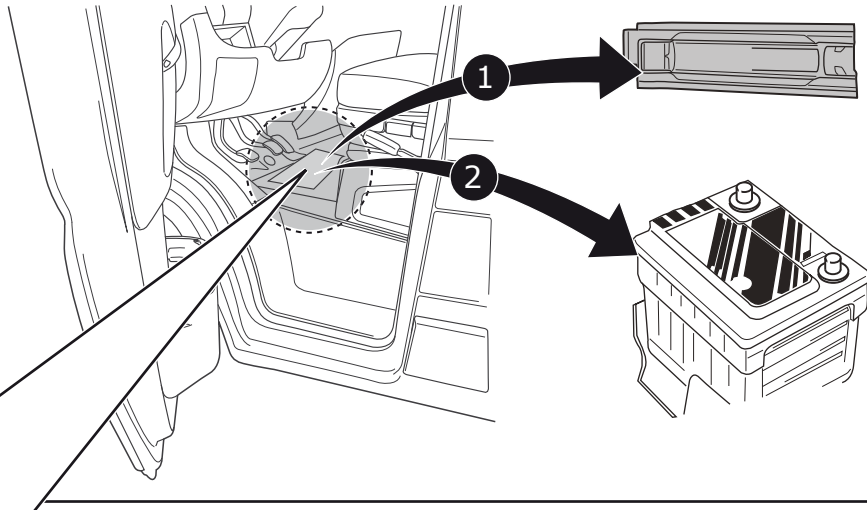

4

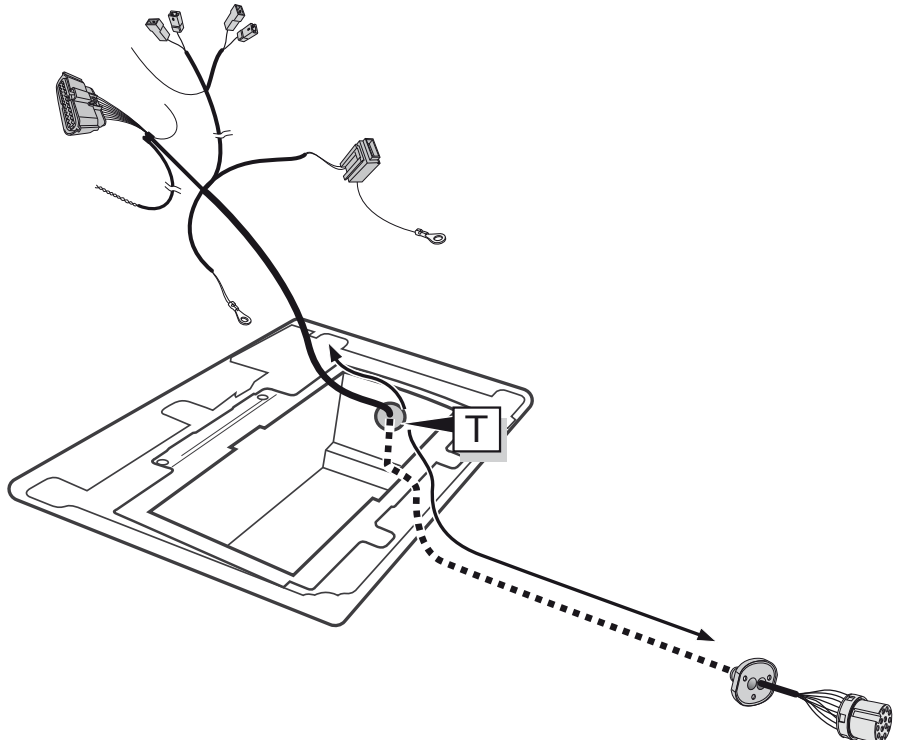
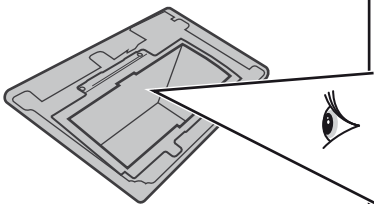

5

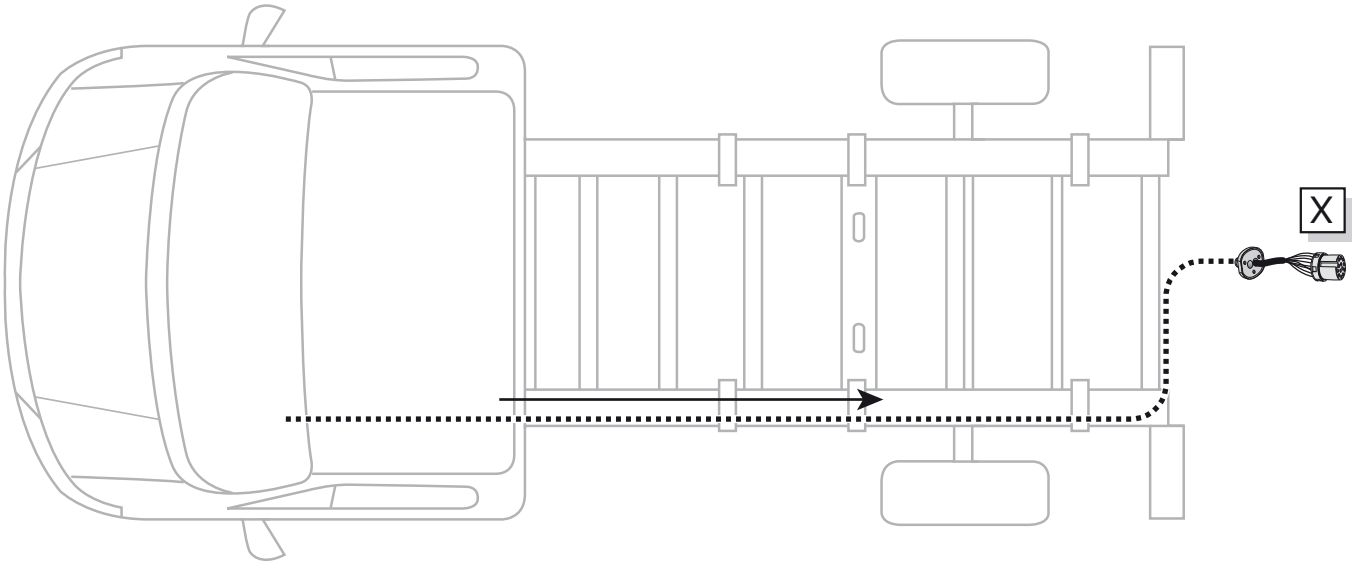

A

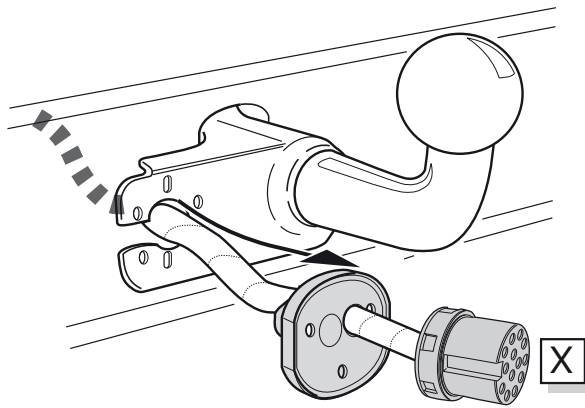

INFO

- (DE) Anschluss Steckdose
- (FR) Connection de la prise
- (NL) Contactdoos aansluiting
- (GB) Socket connection
- (ES) Conexión de la caja de enchufe
- (IT) Allaccio zoccolo



Page 24

B

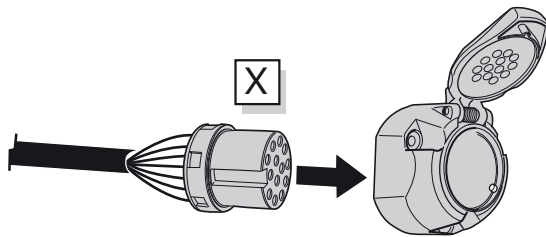

OPTIONAL:
Extension kit
Pin 9, 10, 11 & 13

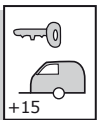
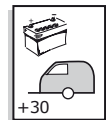

ECS part no.
FI050ZZ

C

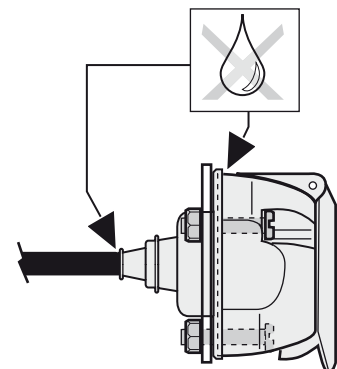
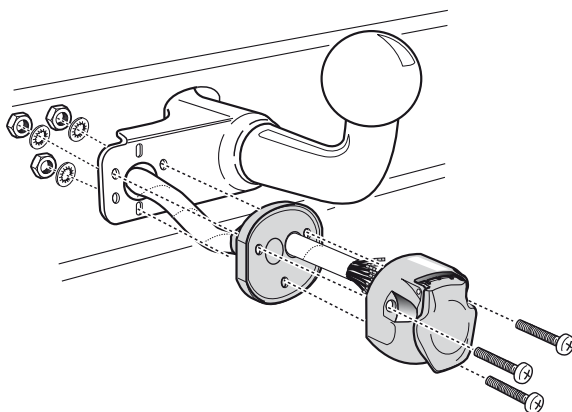

6

1

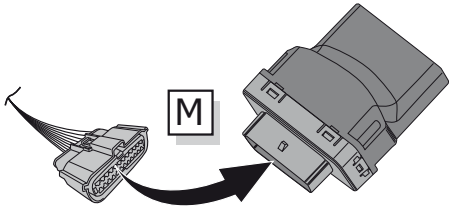

2

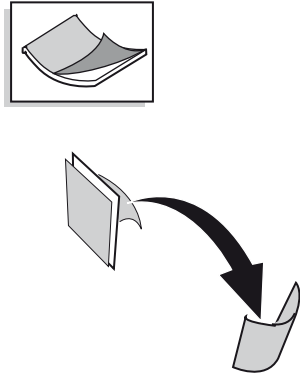

3

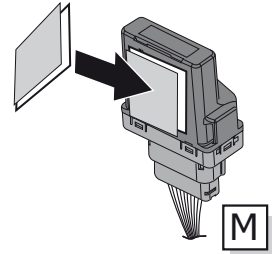

4

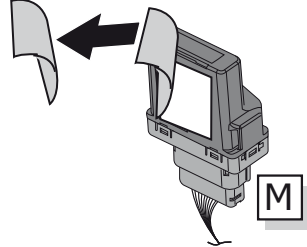

CAN CHECK

➔ Page 21 - 22

7

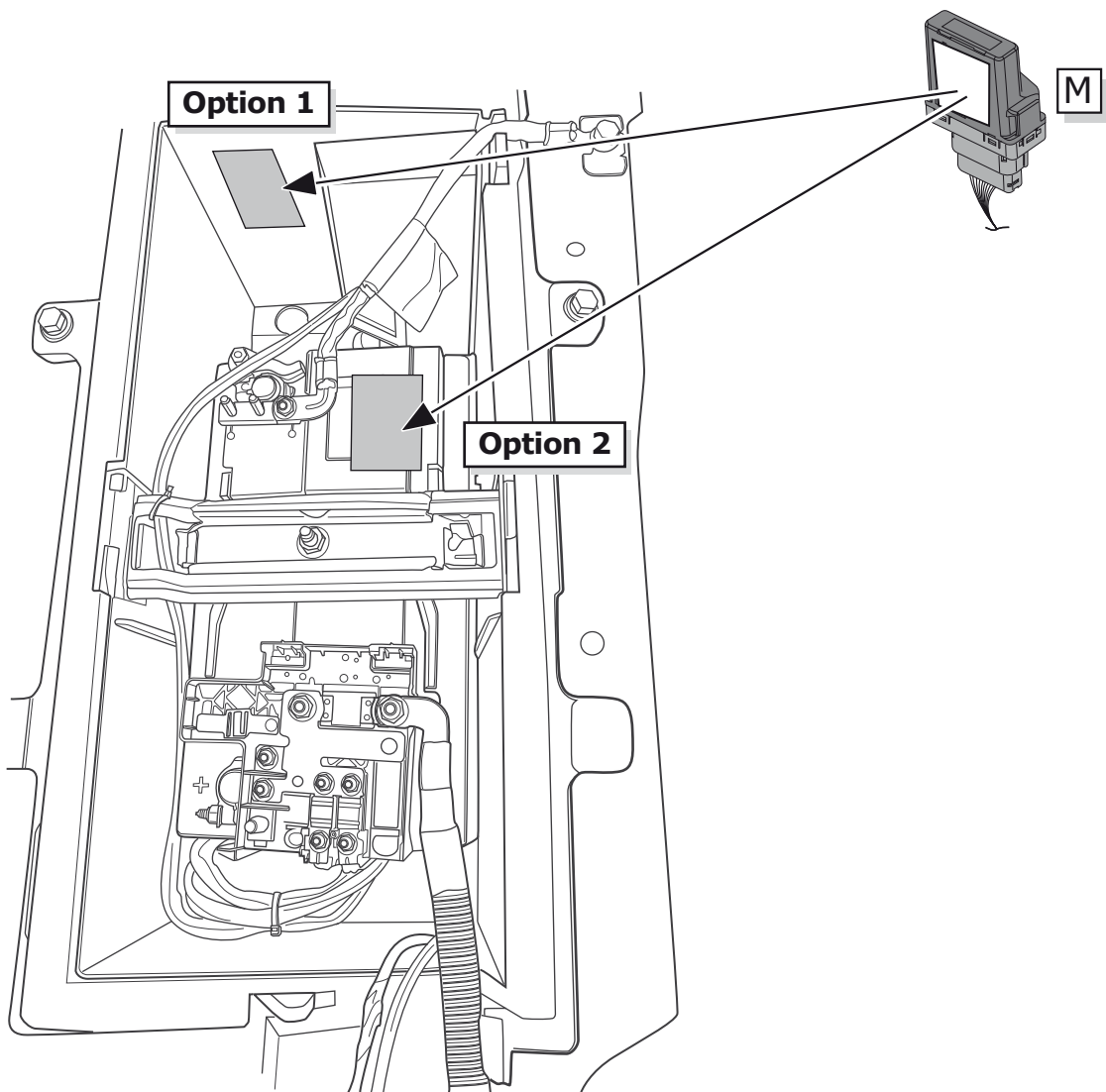
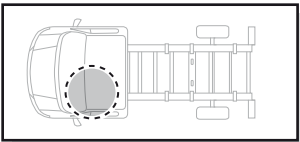

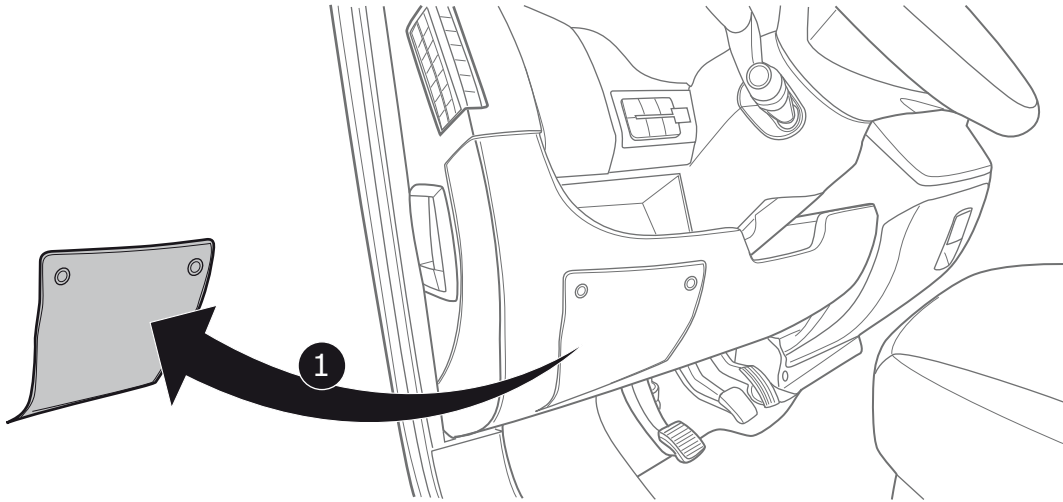
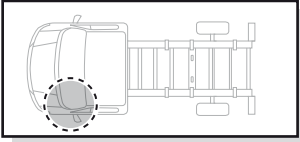

2

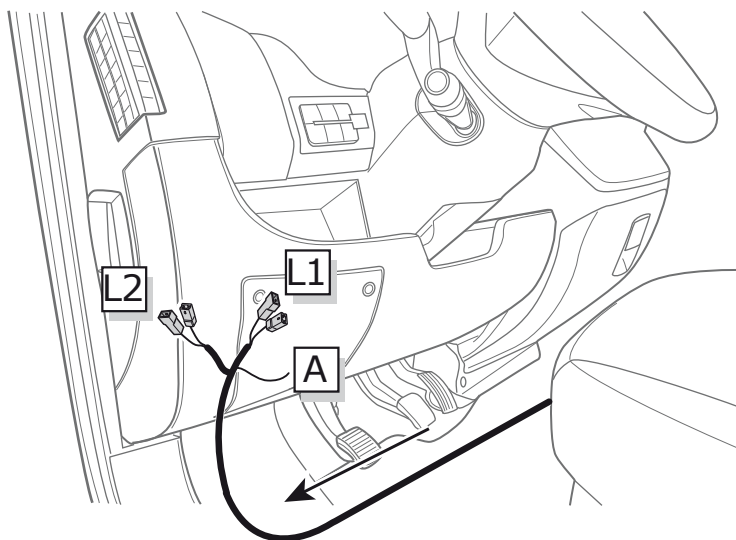

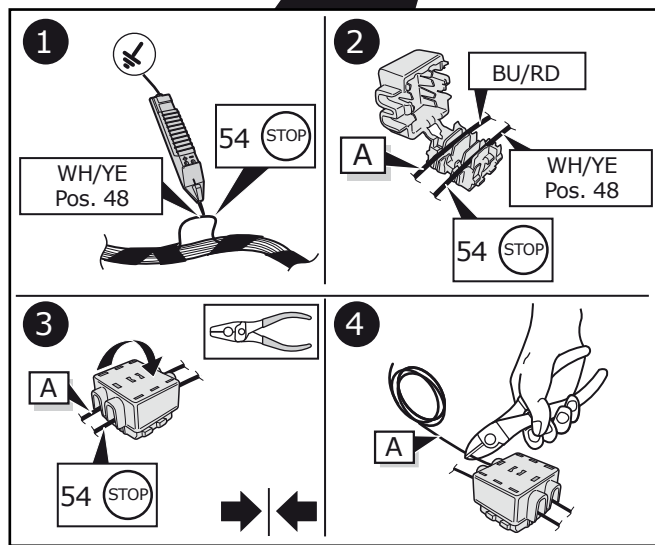
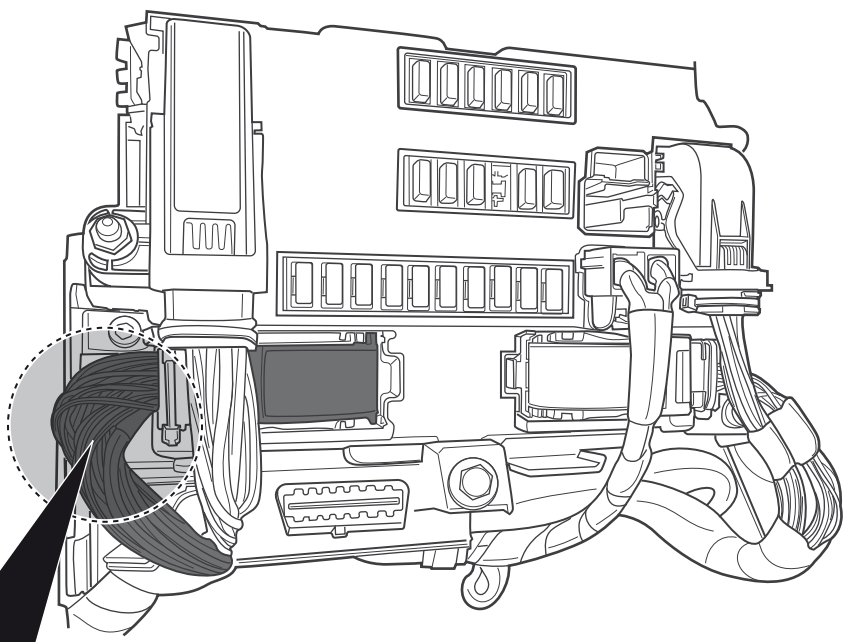
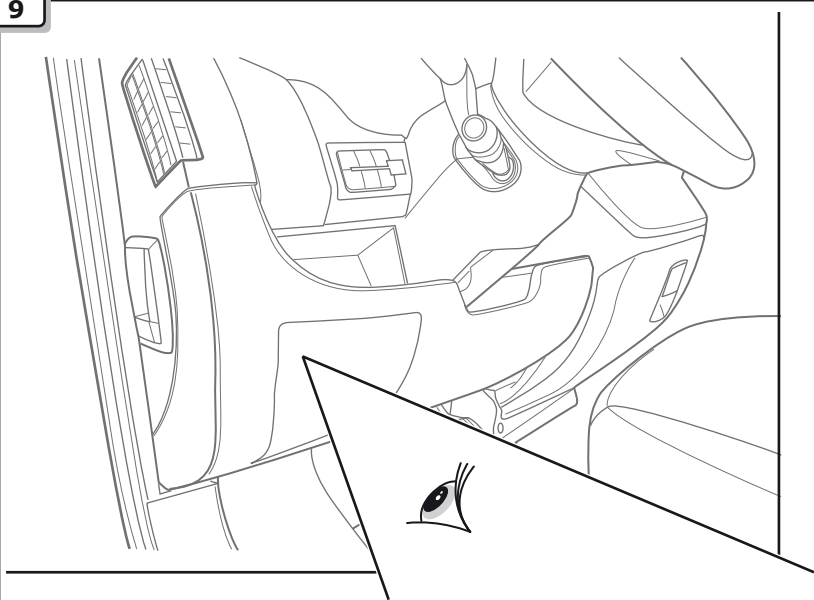

Option 1

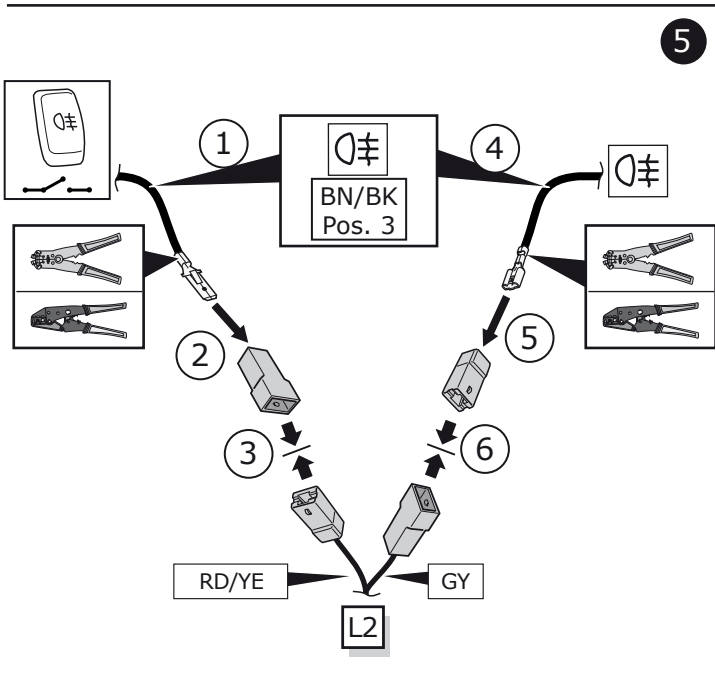
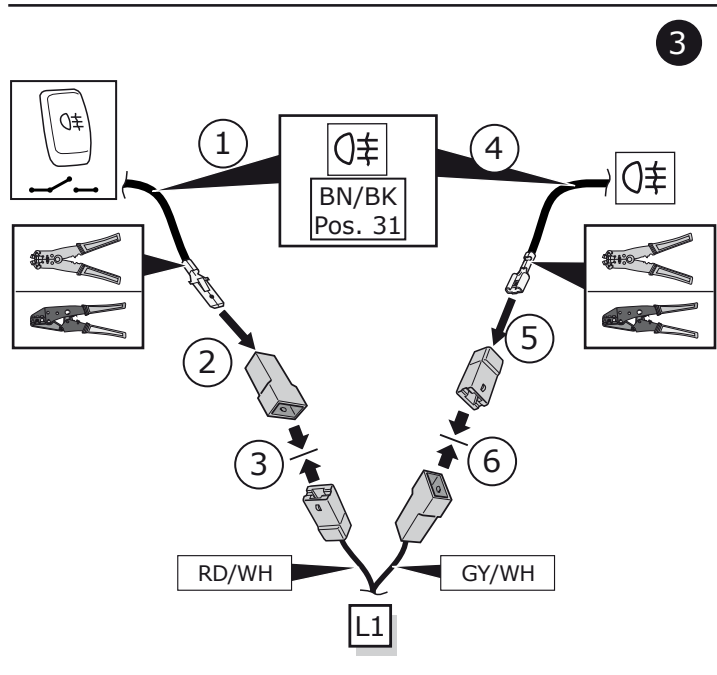
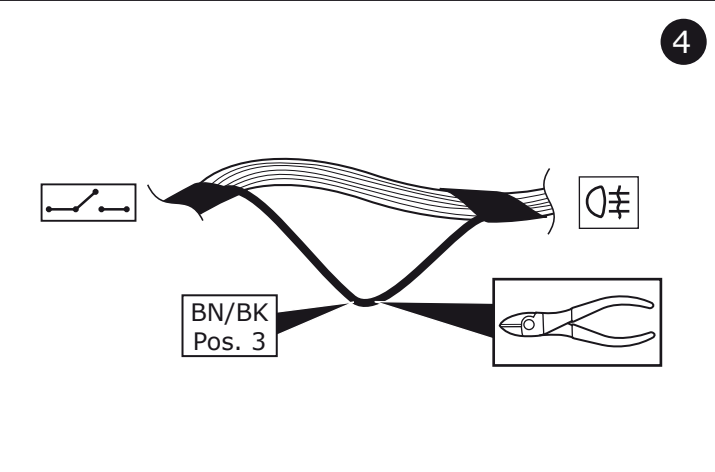
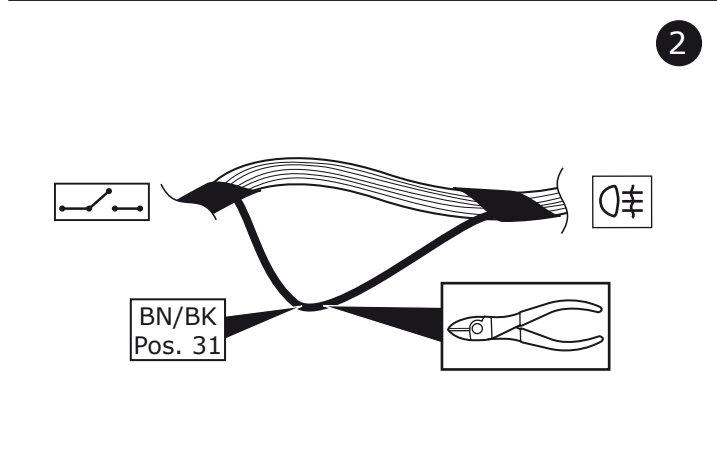
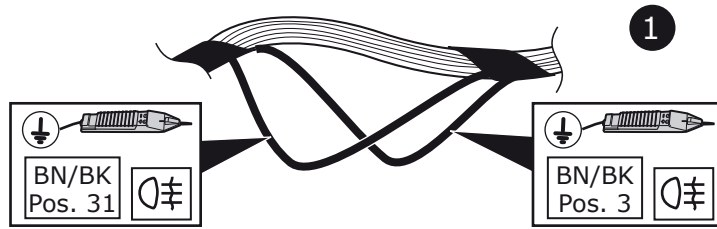
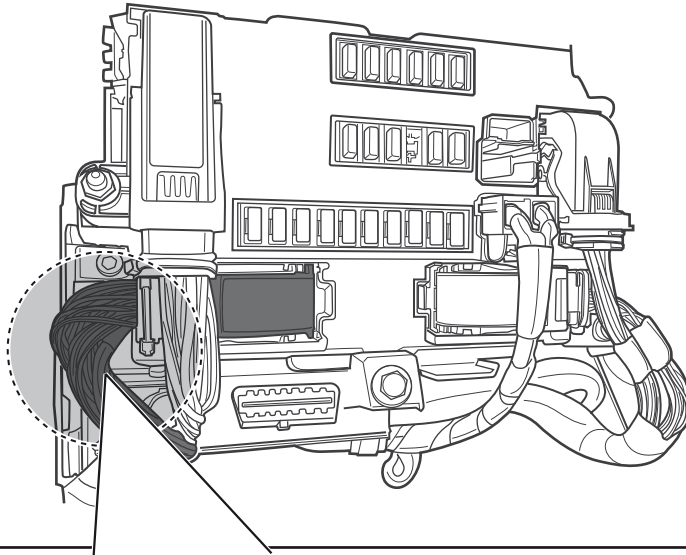

Option 2

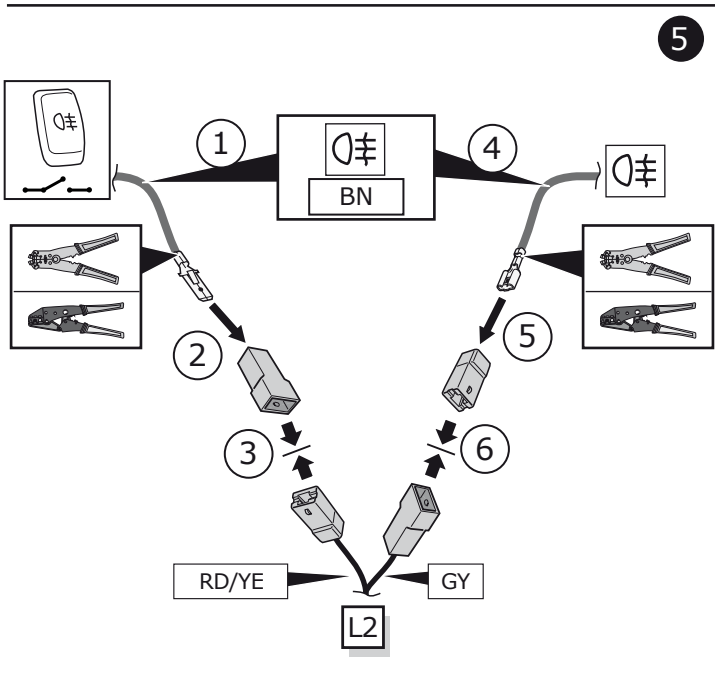
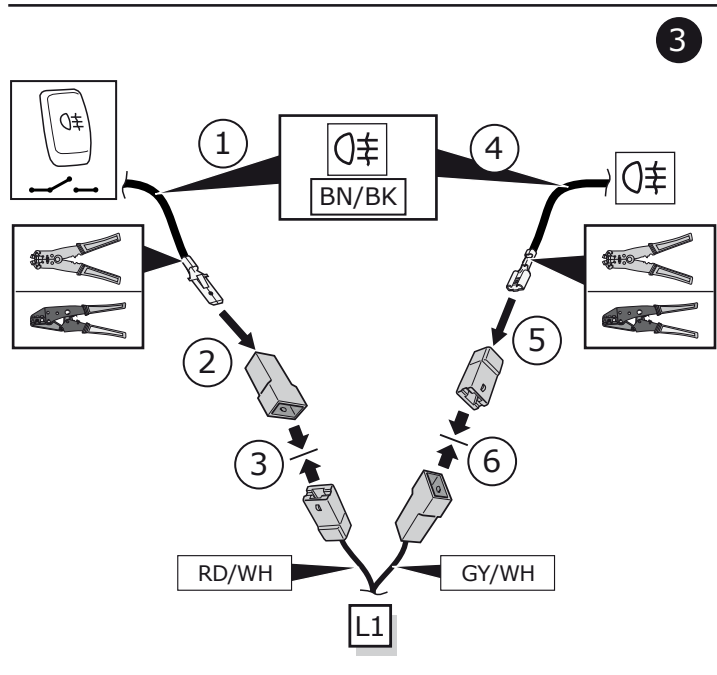
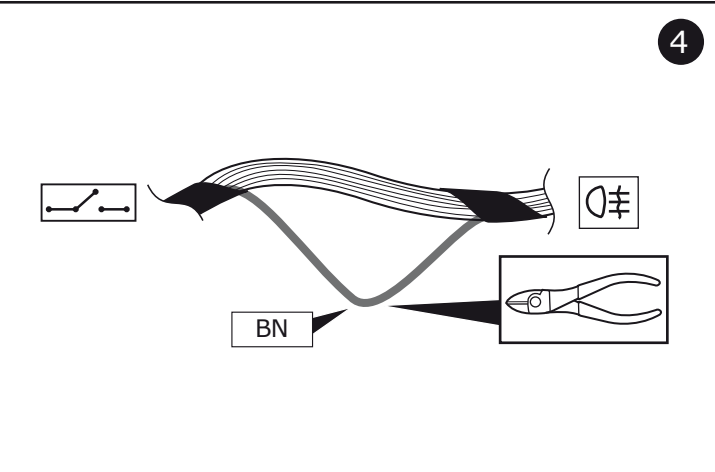
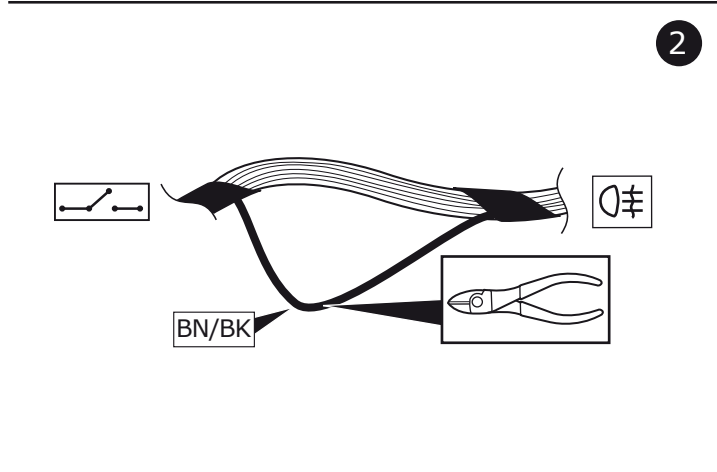
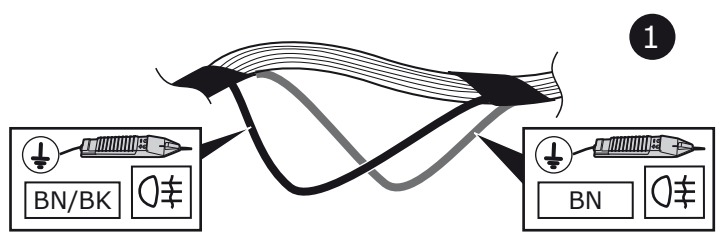
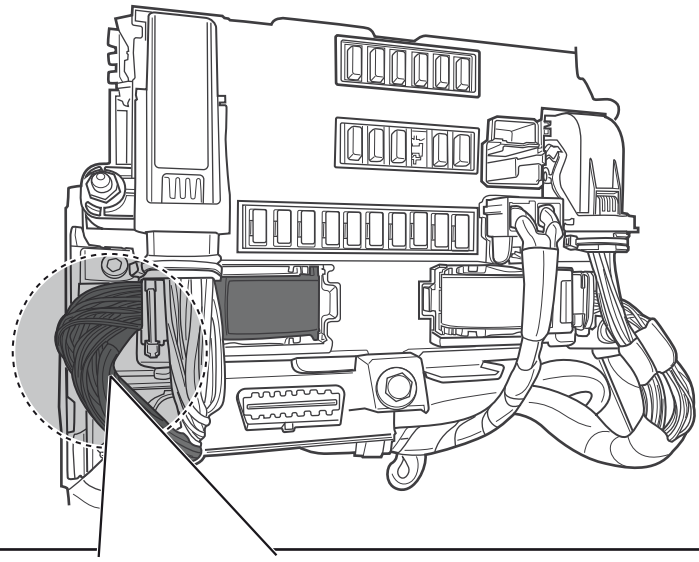

12

Option 1

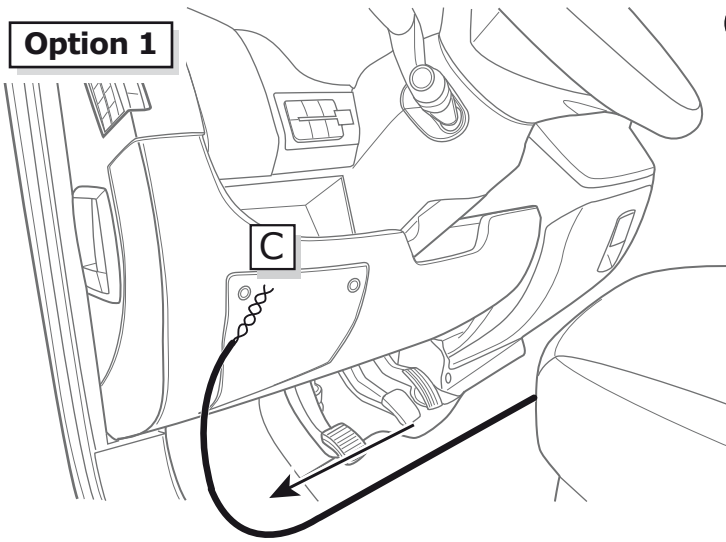

1



2

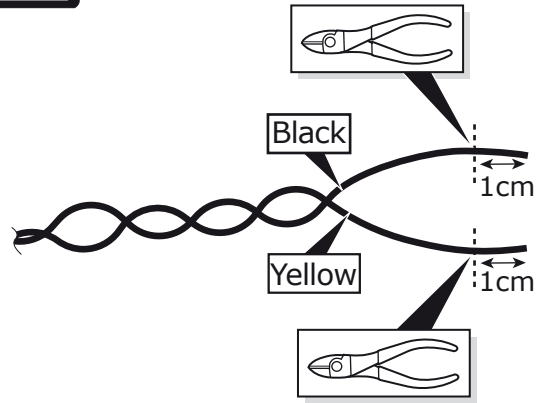

13

Option 1

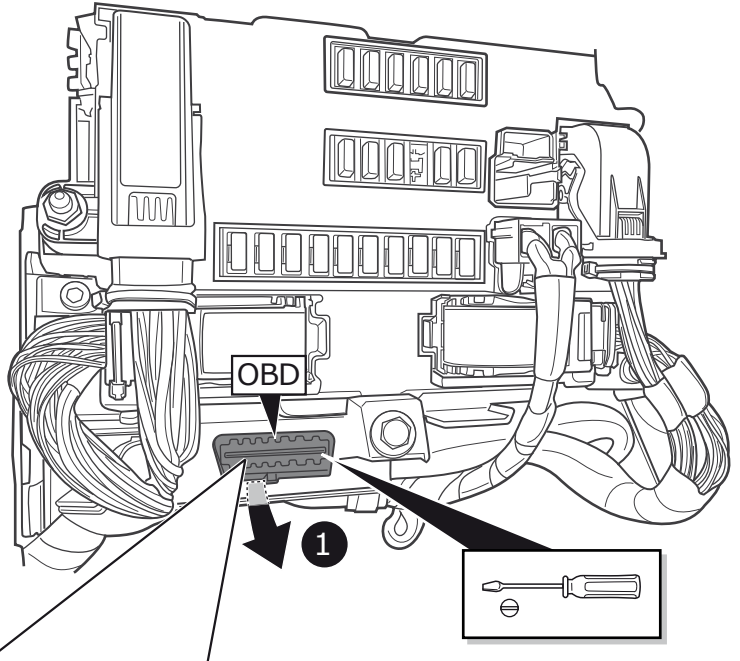
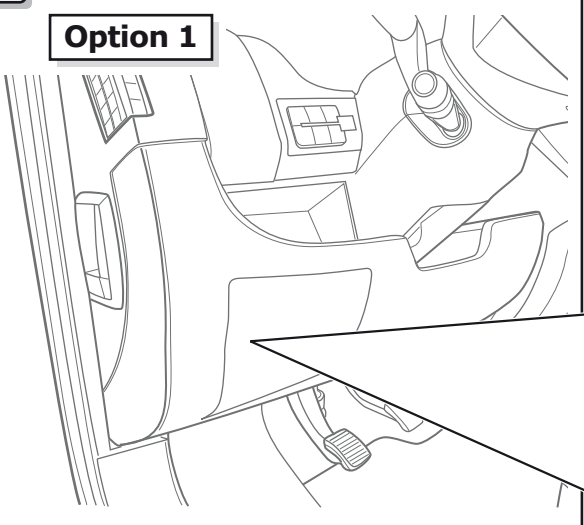

CAN-Data Wire

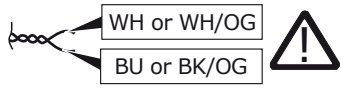

! Important!
Please note informations
in picture 1!

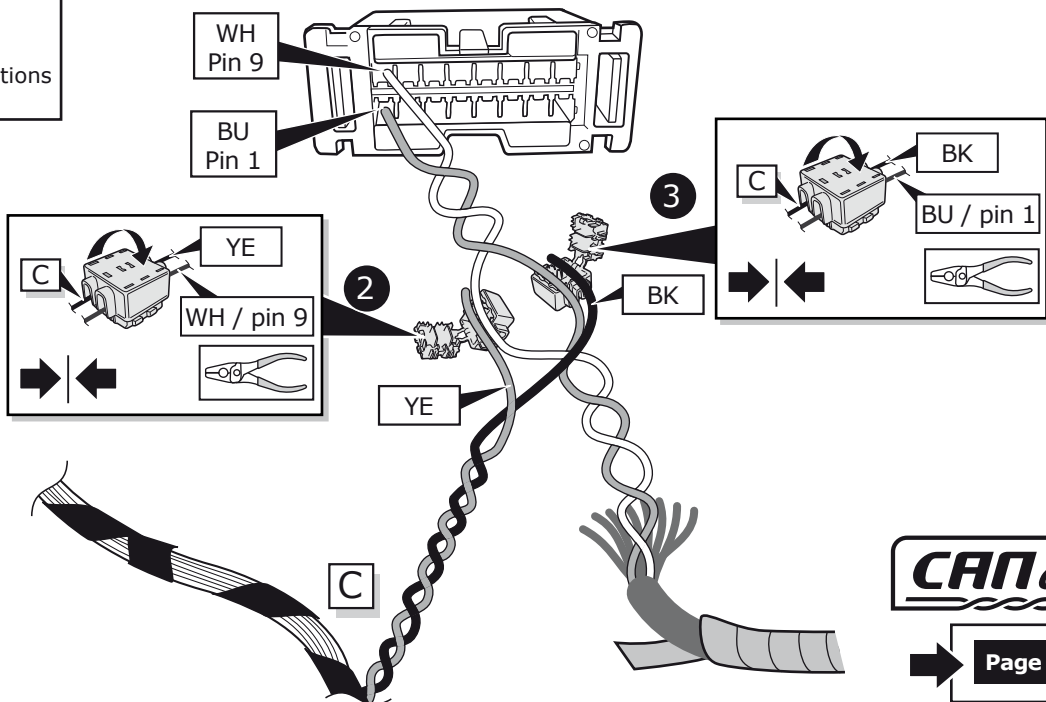

CAN CHECK

➔ Page 21 - 22

14

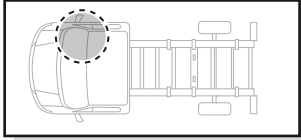

Option 2

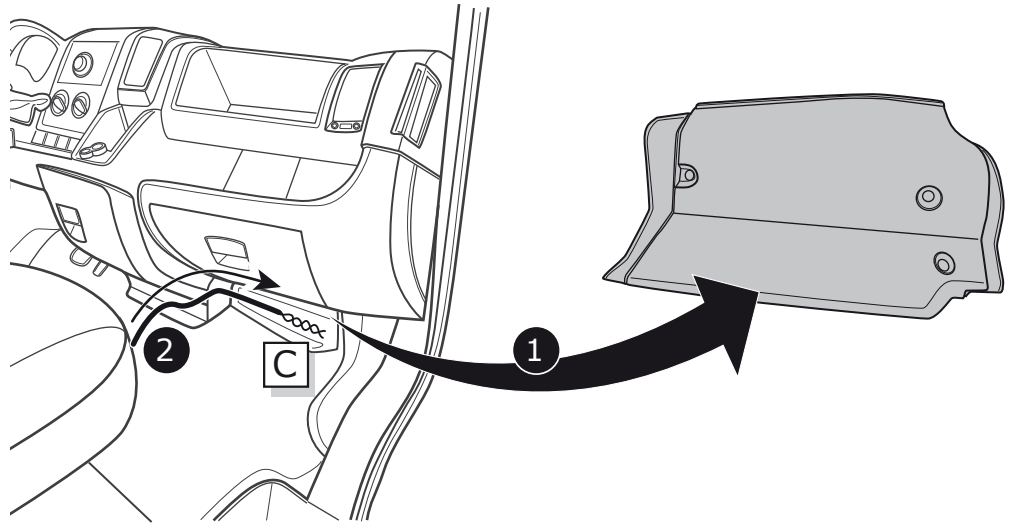

15

Option 2

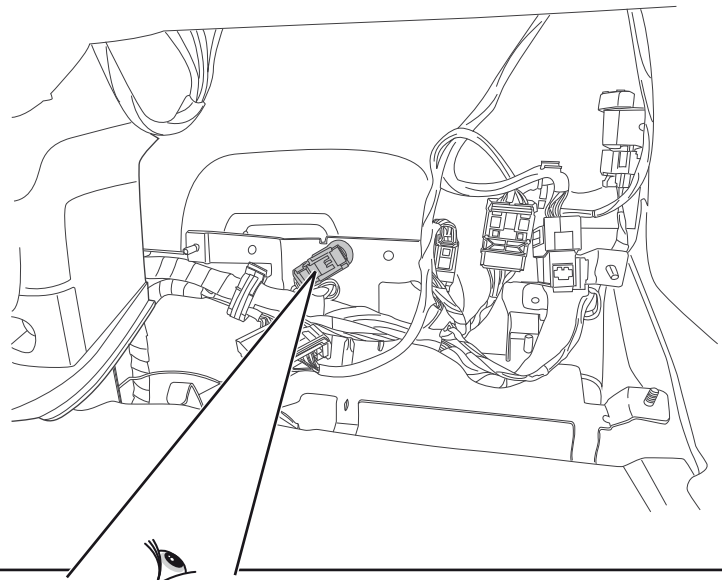
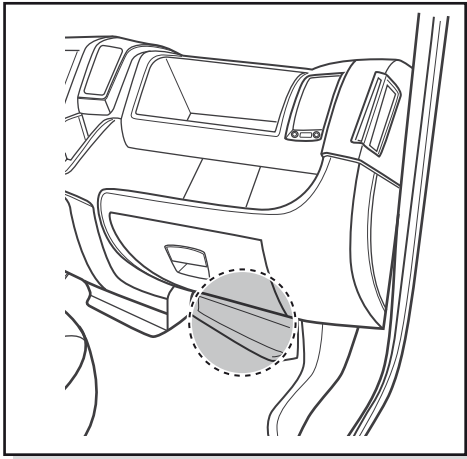

CAN-Data Wire

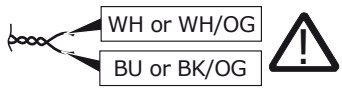

Important!
Please note informations
in picture 1!

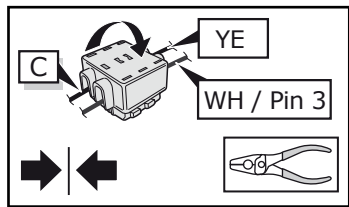

1
Cut to correct length!

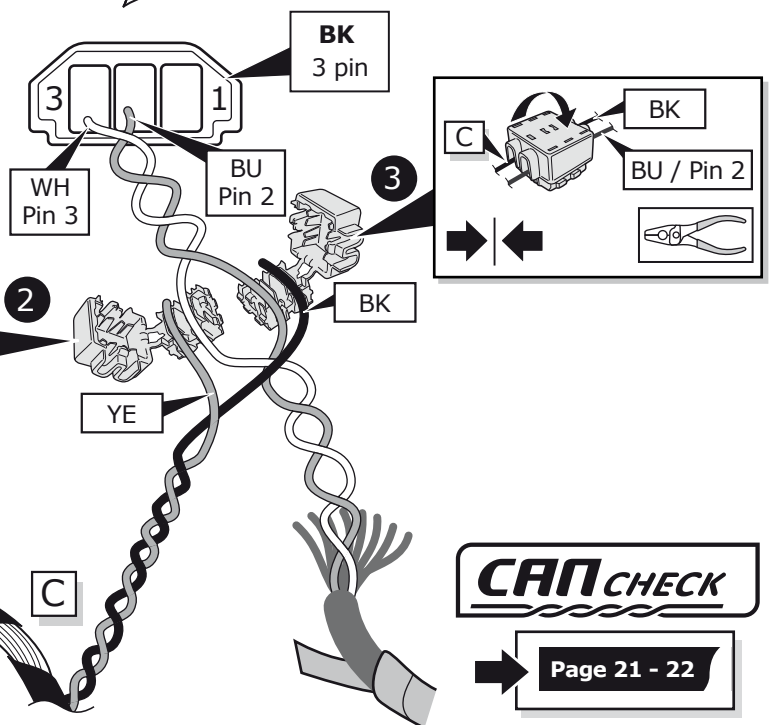
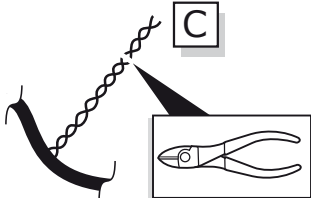

CAN CHECK

Page 21 - 22

16

Vehicles with factory fitted PDC system

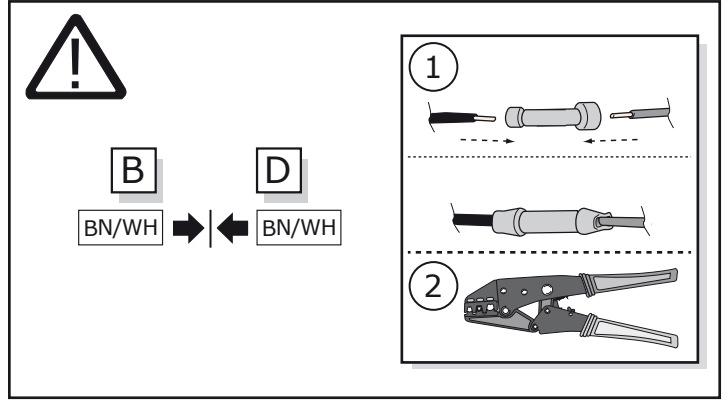
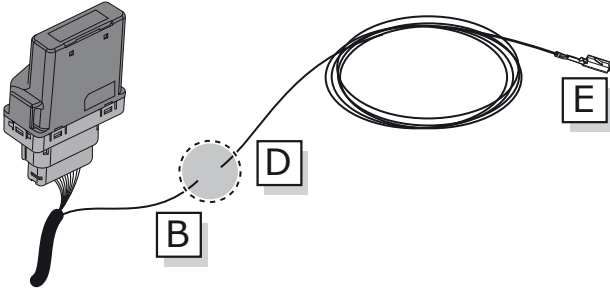
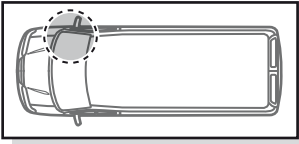

17

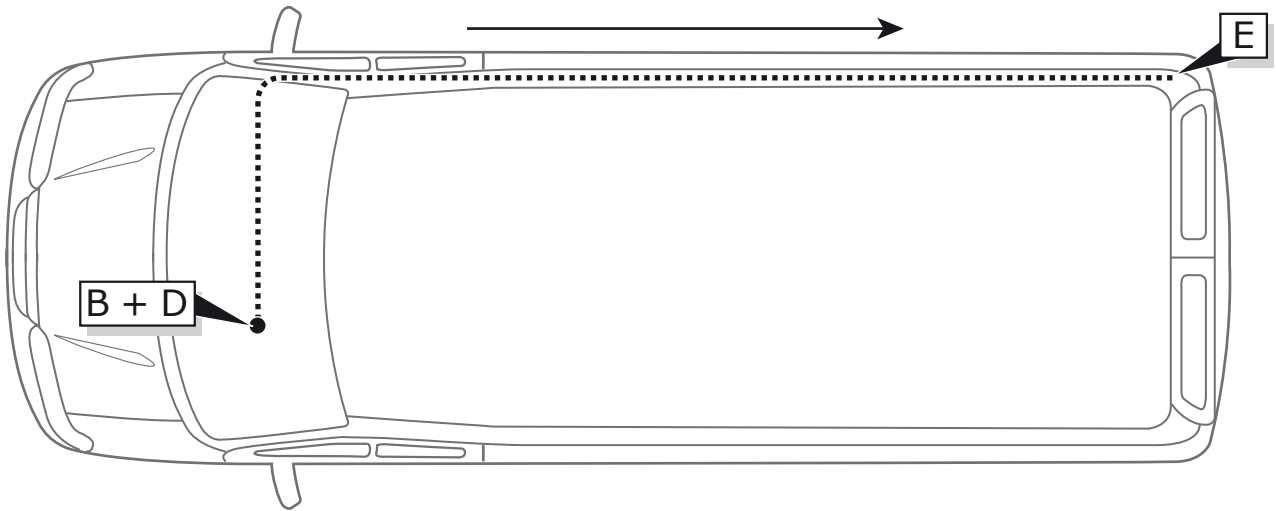

18

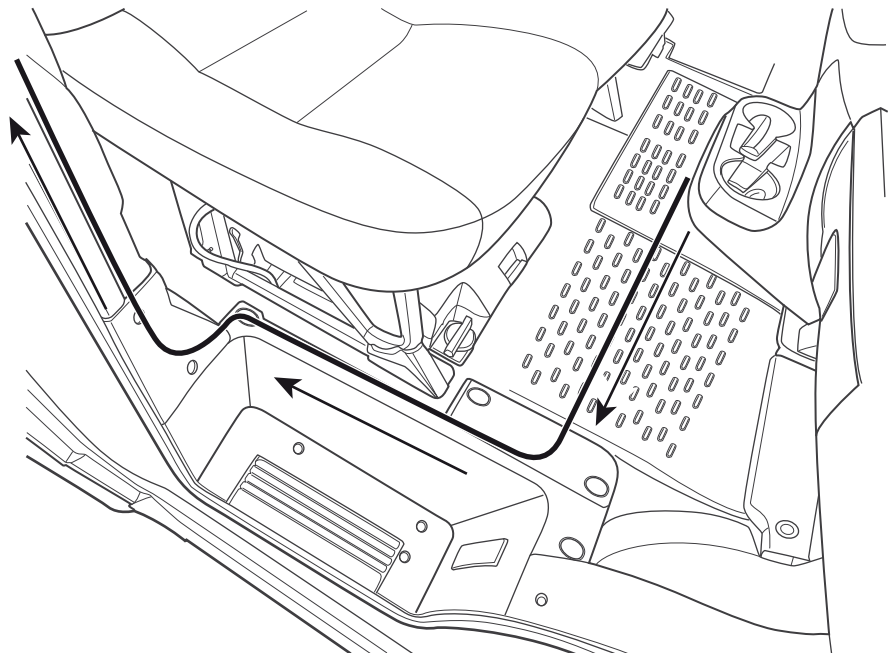
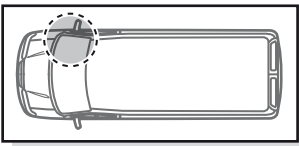

19

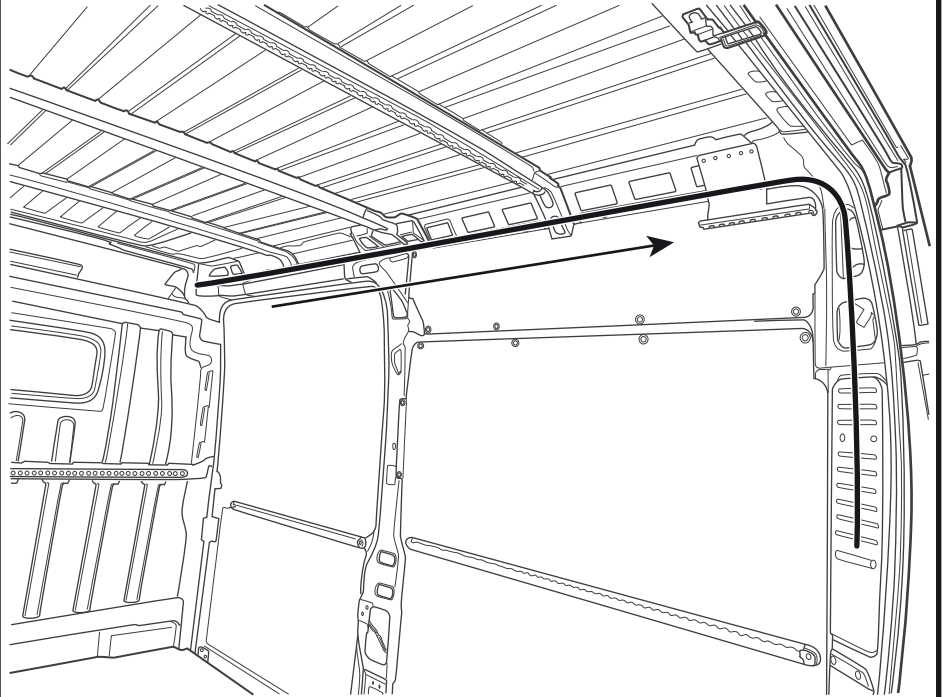
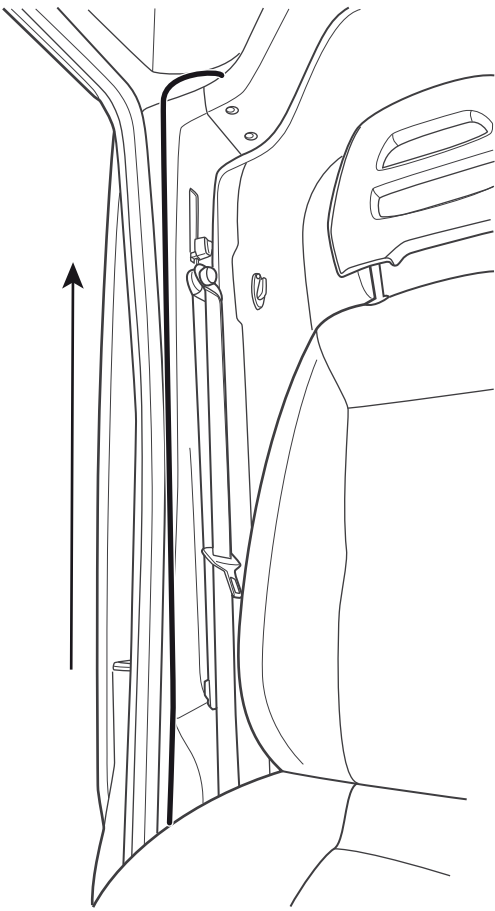
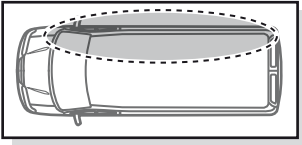

20

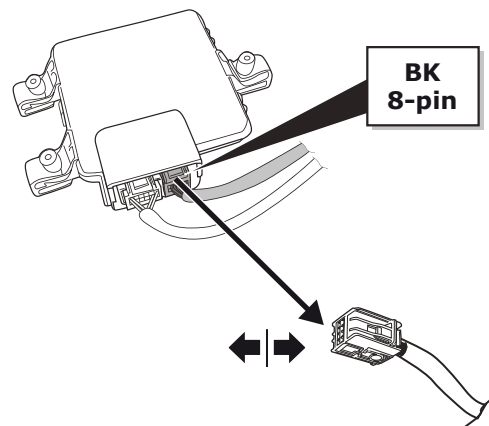
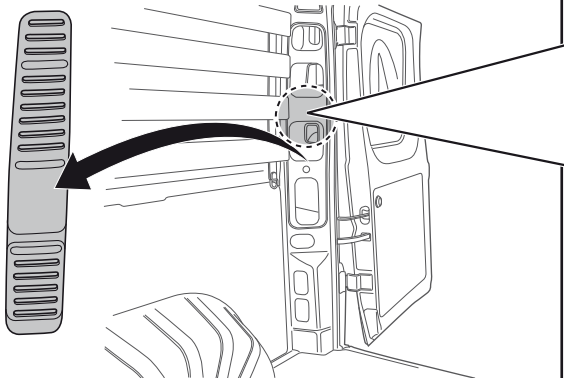
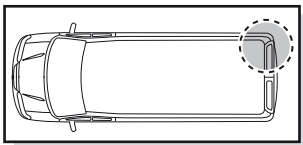

21

1

Option 1

2

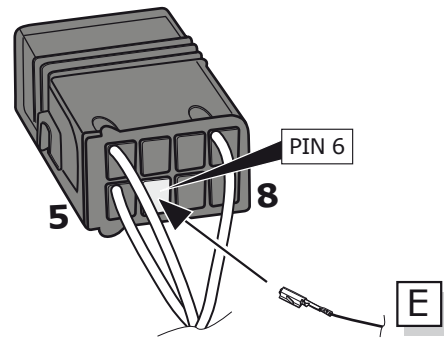
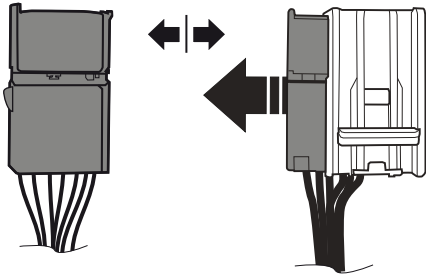

Option 2

2

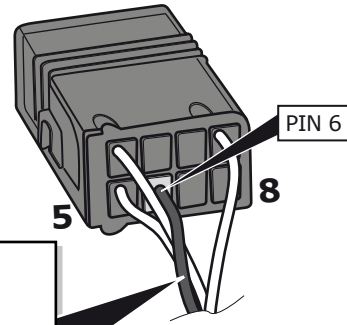
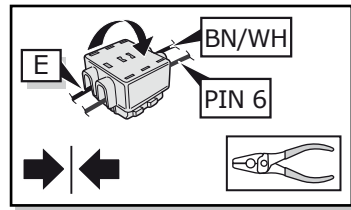
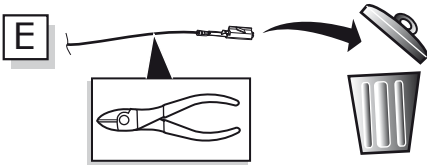

3

4

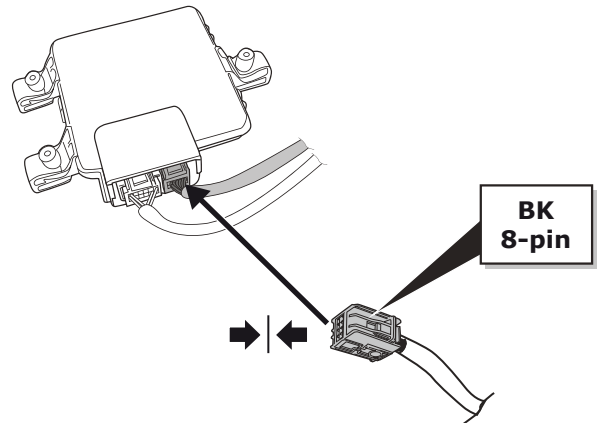
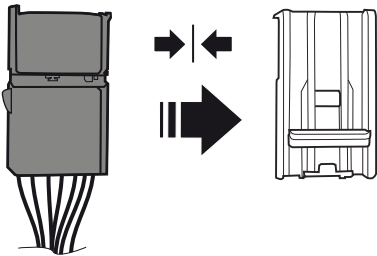

22

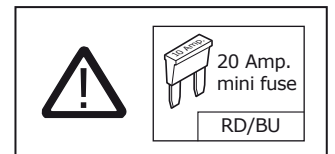
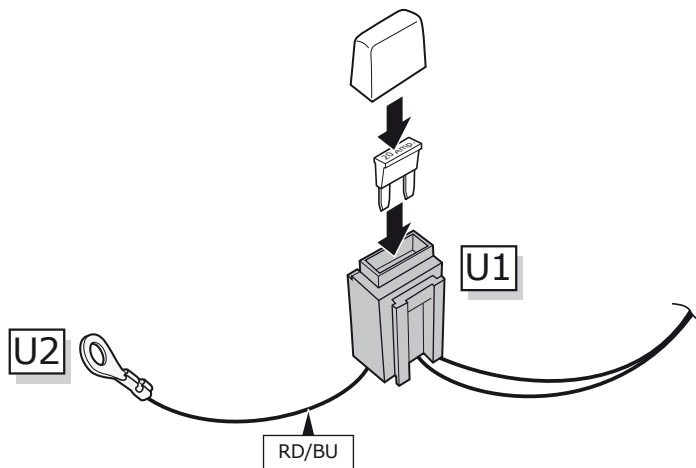

23

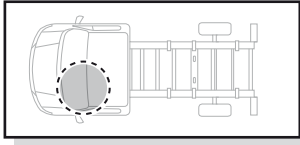

U2

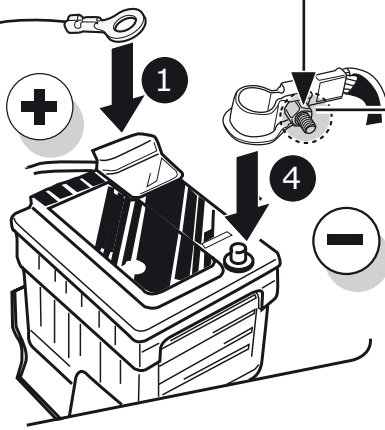

3

G I

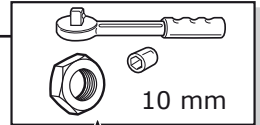

10 mm

2



24



1

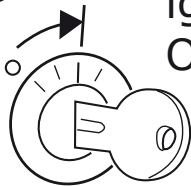

Ign.
ON

2

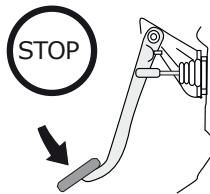

25

Functional test

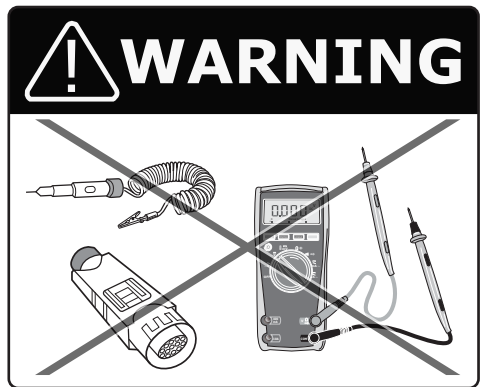
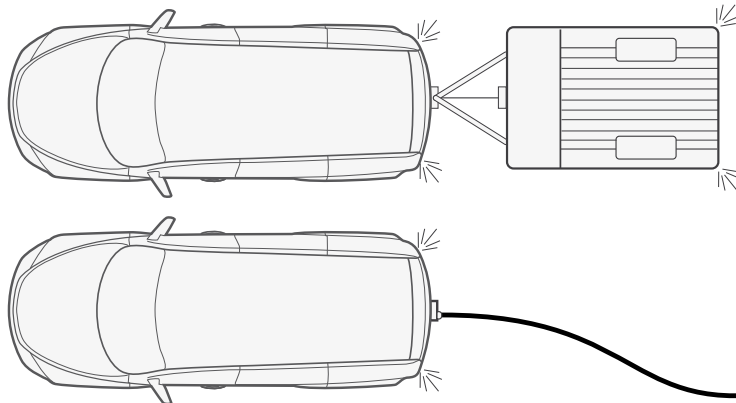
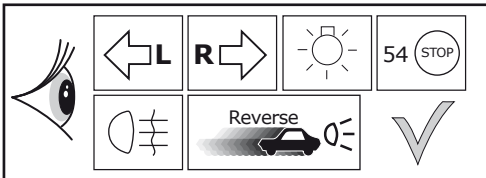

LIGHTMATE

ECS part no.
LIGHTMATEII
LIGHTMATEIII

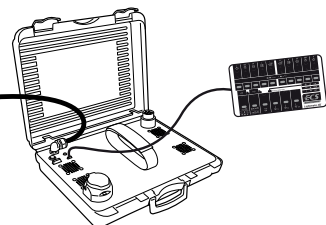



- ⒹE Ausfall Fahrtrichtungsanzeiger Anhänger – Anzeige & Blinker-Ersatzlichtschaltung
- ⒻR Erreur au niveau d'un clignoteur – remplacement d'afficher et clignotant
- ⒼL Falen van richtingaanwijzer – display- en richtingaanwijzerlicht vervanging
- ⒼB Trailer turn indicator failure – display & indicator light substitution
- ⒺS Indicador de fallo remolque – pantalla y indicador para sustitución luz
- ⒻT Guasto dell'indicatore del rimorchio - sostituzione display e spia luminosa

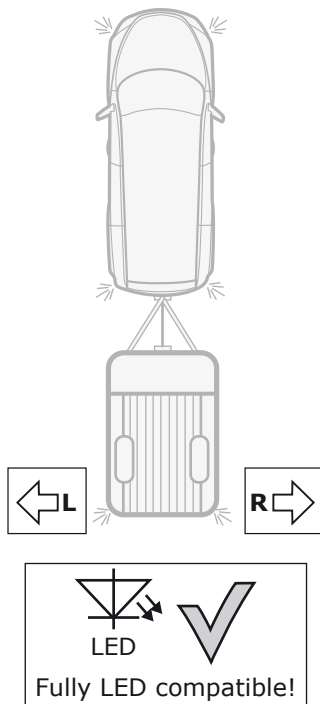

C2 Turn Indicator
Substitution

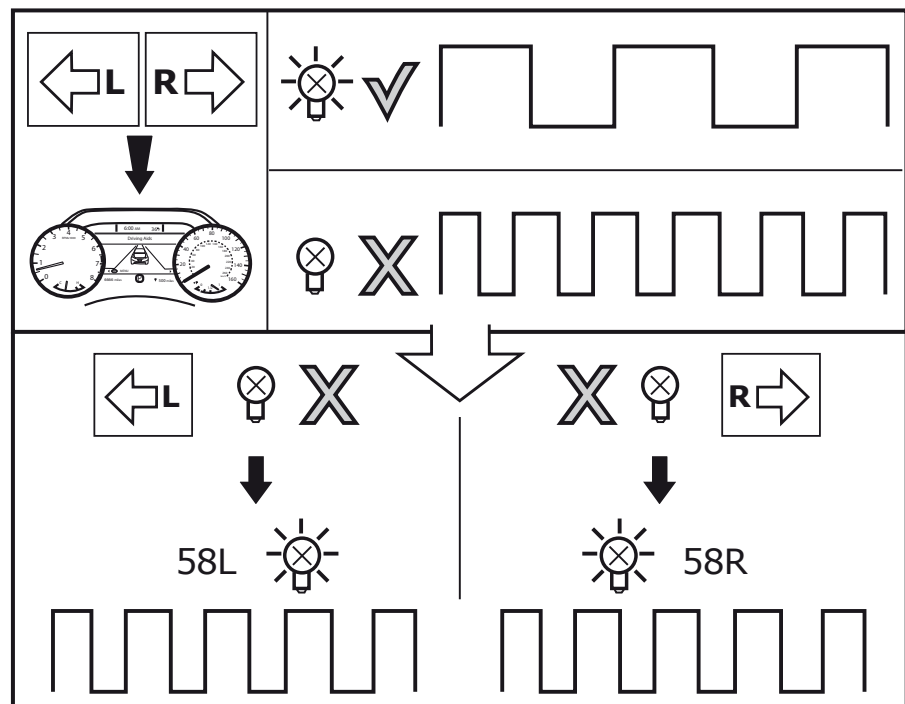

- ⒹE Bei Ausfall Fahrtrichtungsanzeiger Anhänger:
Entsprechende Schlussleuchte übernimmt die Blinkerfunktion.
- ⒻR En cas de non fonctionnement d'un des clignoteurs:
La veilleuse correspondante prend la fonction du clignoteur.
- ⒼL Bij het falen van een richtingaanwijzer:
Bijbehorend achterlicht zal de richtingaanwijzerfunctie overnemen.
- ⒼB In case of trailer turn indicator failure:
Corresponding tail light will take over the indicator light function.
- ⒺS En caso que el indicador de fallo remolque ilumine:
Correspondiente luz trasero tomara control sobre el indicador de fallo.
- ⒻT In caso di guasto dell'indicatore del rimorchio:
Il fanale posteriore corrispondente sostituirà la funzione della spia luminosa.

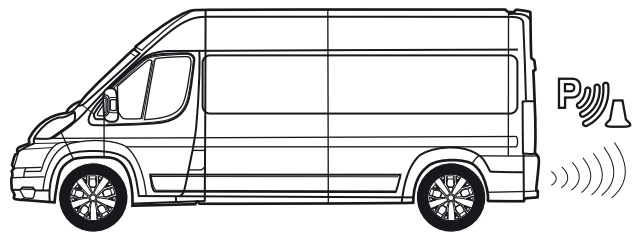
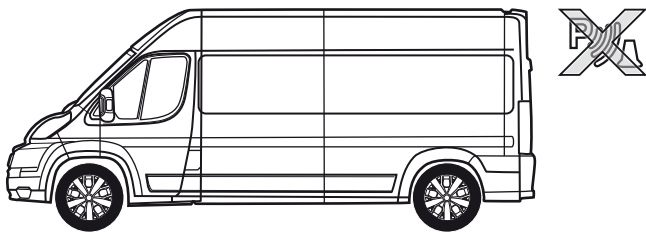
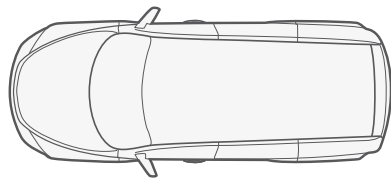
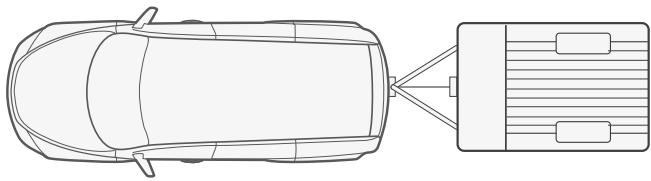

Please note: Limited functionality of assistance systems!

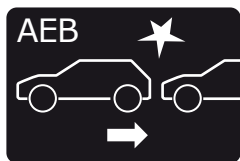
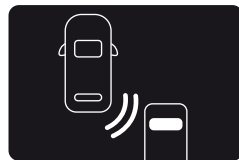
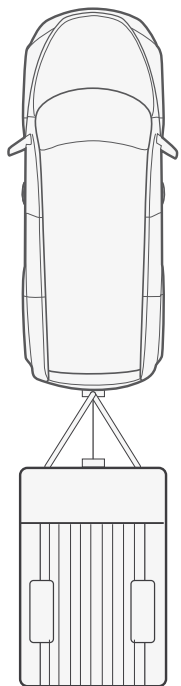

29

Optional

Adapter socket

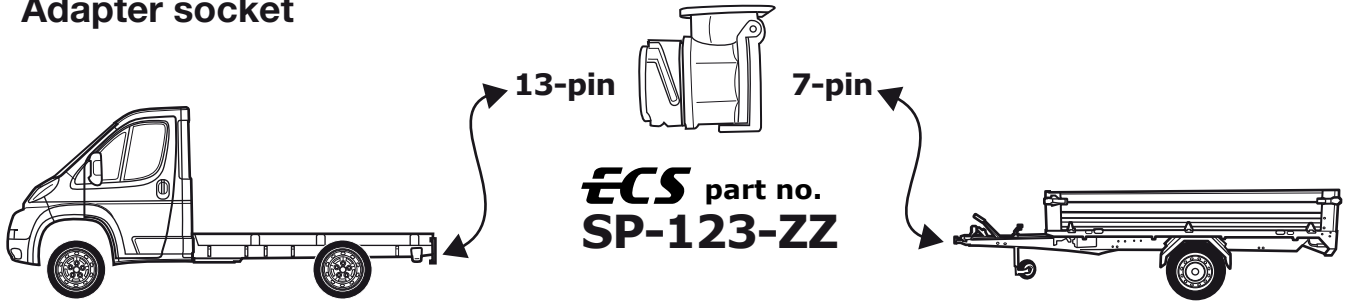

30

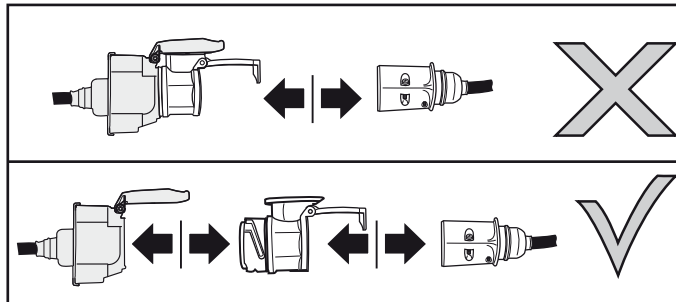
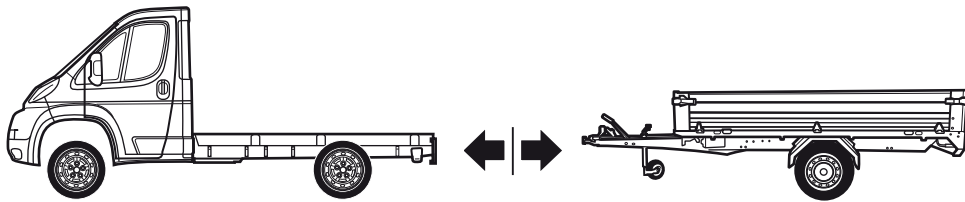

CAN CHECK

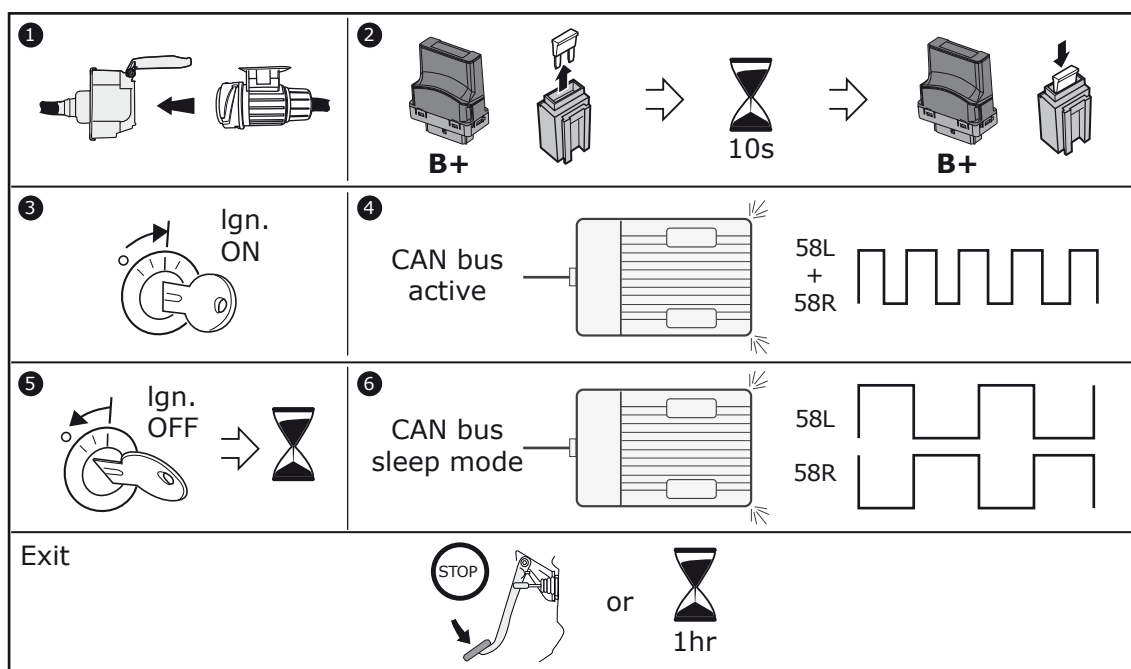

Der fehlerfreie Anschluss des Anhängermoduls an den fahrzeugseitigen CAN-Bus wird mit dem ECS CAN-Check schnell und einfach kontrolliert:

1. Anhänger, Beladungsträger oder Prüfeinrichtung an die Anhängersteckdose anschliessen
2. Spannungsversorgung Anhängermodul für min. 10 Sekunden unterbrechen
3. Zündung einschalten
4. Anzeige CAN-Bus aktiv: Beidseitiges regelmässiges Aufleuchten der Anhänger-Rückleuchten
5. Zündung ausschalten, alle Türen und Hauben schliessen, CAN-Bus Sleep-Mode abwarten
6. Anzeige CAN-Bus Sleep-Mode: Wechselseitiges Aufleuchten der Anhänger-Rückleuchten

DE

Une connexion sans erreurs entre le boîtier électronique et le système multiplexé peut être contrôlé rapidement et simplement avec l'aide de vérification d'ECS "CAN-Check":

1. Connectez un remorque ou testeur sur la prise
2. Interrompre l'alimentation du boîtier électronique de 10 secondes minimal
3. Mettre le contact
4. Affichage CAN-Bus actif: Clignotement régulier des veilleuses de la remorque des 2 cotés
5. Coupez le contact, fermez les portes, le coffre, et attendre la mise en sommeil du véhicule
6. Affichage mode sommeil du CAN-Bus: Eclairage alterné des feux arrières de la remorque

FR

Een foutloze connectie tussen de trailer module en het CAN-bus system van de auto kan eenvoudig en snel nagekeken worden middels de ECS CAN-check:

1. Sluit een trailer, lastdrager of testapparaat aan op de stekkerdoos
2. Onderbreek de stroomtoevoer naar de module voor minstens 10 seconden
3. Ontsteking aanzetten
4. Weergave actieve CAN-bus: regelmatig knipperen van achterlichten op de trailer aan beide kanten
5. Ontsteking uitschakelen, sluit alle deuren, kofferbak en motorkap, wacht op CAN-bus slaapmodus
6. Weergave slaapmodus CAN-Bus: wisselende verlichting van de trailer lampen

NL

CAN CHECK

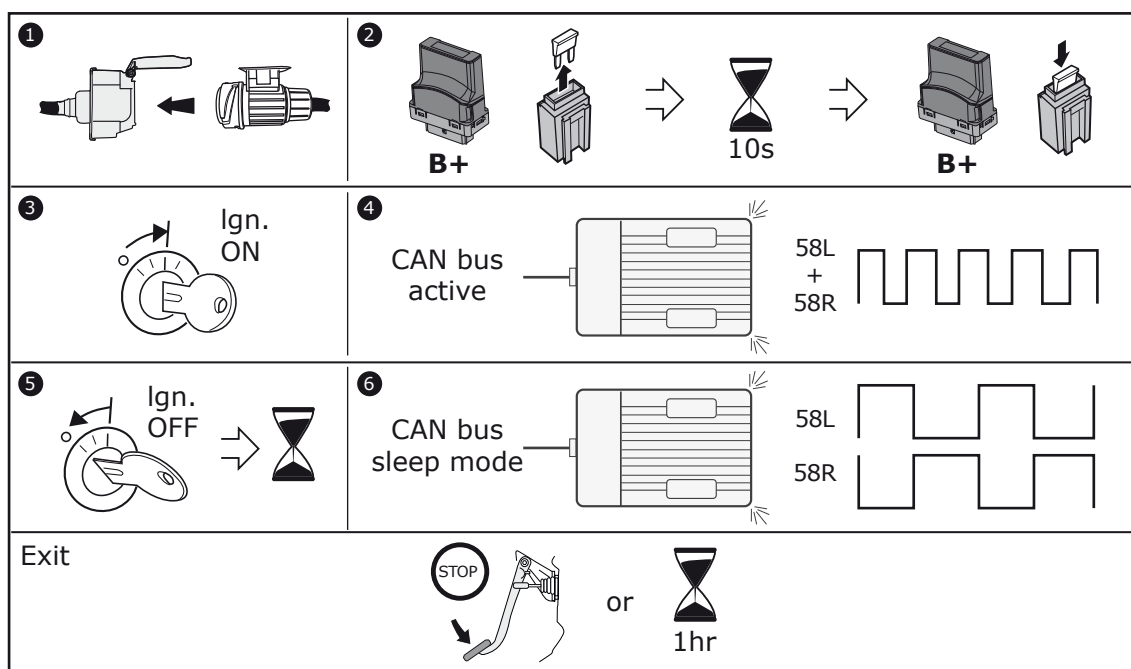

The faultless connection of the trailer module to the vehicle-side CAN-bus can be checked quick and easy with the ECS CAN-check:

1. Connect a trailer, load carrier or test device to the trailer socket
2. Interrupt power supply to trailer module for at least 10 seconds
3. Switch on ignition
4. CAN bus active display: Regular double-sided flashing of the trailer tail lights
5. Switch off ignition, close all doors and hoods, wait for CAN-bus sleep mode
6. CAN bus sleep mode display: Alternate lighting of the trailer tail lights

GB

Verifique rápidamente con el ECS CAN-check si la conexión de la centralita del remolque al CANBUS está hecha correctamente:

1. Conecta un remolque, portabicicletas o dispositivo de control a la base del remolque
2. Interrumpa durante unos 10 segundos la alimentación continua de la centralita del remolque
3. Encienda el encendido
4. Visualización bus CAN activo: Ambas luces traseras del remolque parpadean al mismo tiempo
5. Apaga el encendido, cierra las puertas y capó del vehículo y espera a que el bus CAN entre en el "modo sleep"
6. Visualización bus CAN en "modo sleep": Luces traseras del remolque parpadean alternativas

ES

La connessione corretta della centralina del rimorchio sul veicolo CAN-bus può essere verificata rapidamente e facilmente con ECS CAN-check:

1. Collegare un rimorchio, un supporto di carico o un dispositivo di prova alla presa del rimorchio
2. Interrompere l'alimentazione della centralina del rimorchio per almeno 10 secondi
3. Attivare l'accensione
4. Display CAN-bus attivo: Lampeggiamento su due lati regolare delle luci posteriori del rimorchio
5. Disattivare l'accensione, chiudere tutte le portiere e le cappe, attendere la modalità di sospensione CAN-bus
6. Visualizzazione modalità sleep CAN-bus: Illuminazione alternata delle luci posteriori del rimorchio

IT

Products & Service: <https://www.ecs-electronics.nl/test-equipment>

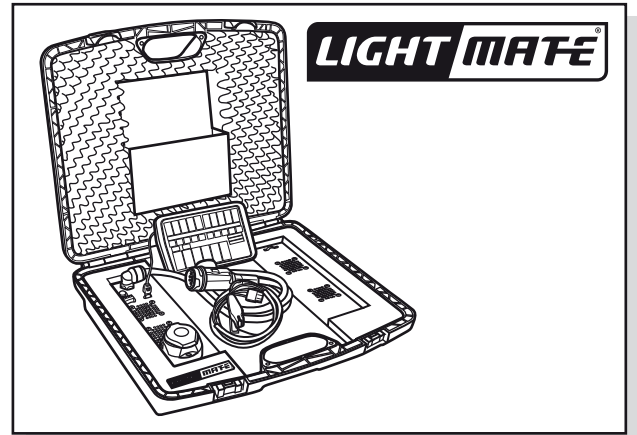
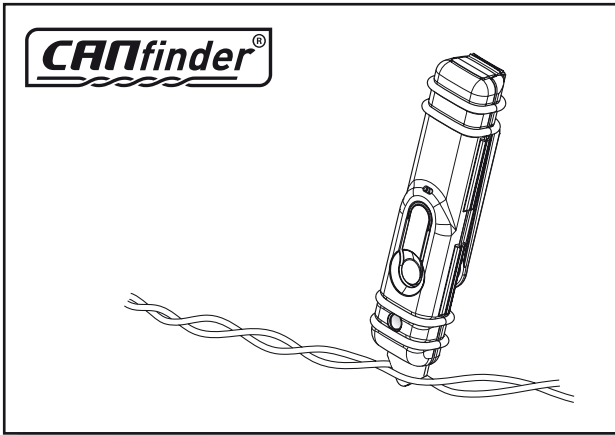

**FITTERS
TECHNICAL
SUPPORT**



**MONDAY TO FRIDAY
08.00 - 12.00
13.00 - 17.00**

ts@ecs-electronics.nl
www.ecs-electronics.nl
tel: +31 (0)76 573 0020

INFO

- (DE) Anschluss Steckdose (ES) Conexión de la caja de enchufe (CZ) Objímkový konektor (GR) Υποδοχή σύνδεσης
- (FR) Connection de la prise (IT) Allaccio zoccolo (DK) Stikdåse forbindelse (NO) Tilkobling koblingsboks
- (NL) Contactdoos aansluiting (SE) Anslutning kontaktdosa (FI) Pistorasia liitäntä (PL) Połączenie przez gniazdo
- (GB) Socket connection

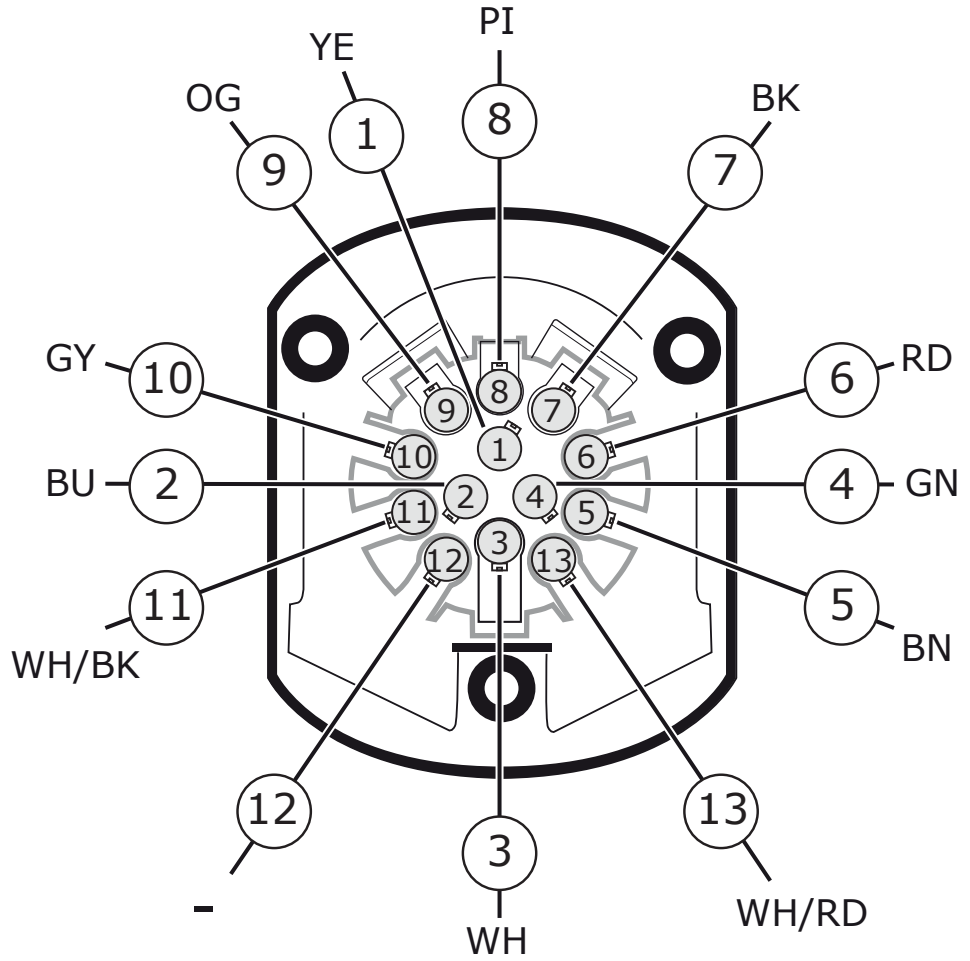
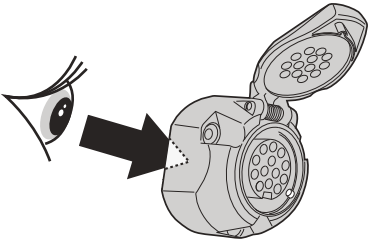

- (DE) Anschluss Steckdose (ES) Conexión de la caja de enchufe (CZ) Objímkový konektor (GR) Υποδοχή σύνδεσης
- (FR) Connection de la prise (IT) Allaccio zoccolo (DK) Stikdåse forbindelse (NO) Tilkobling koblingsboks
- (NL) Contactdoos aansluiting (SE) Anslutning kontaktdosa (FI) Pistorasia liitäntä (PL) Połączenie przez gniazdo
- (GB) Socket connection

Optional: **ECS** part no. **FI050ZZ**

DIN/ISO 11446													
Pmax	21W	21W		21W	52W	3x21W	52W	21W	180W/15Amp.	180W/15Amp.			
	YE	BU	WH	GN	BN	RD	BK	PI	OG	GY	WH/BK	-	WH/RD

COLORTABLE

	BK	BN	BU	GY	GN	WH	YE	OG	PE	PI	RD
(DE)	Schwarz	Braun	Blau	Grau	Grün	Weiß	Gelb	Orange	Violett	Rosa	Rot
(FR)	Noir	Marron	Blue	Gris	Vert	Blanc	Jaune	Orange	Violet	Rose	Rouge
(NL)	Zwart	Bruin	Blauw	Grijs	Groen	Wit	Geel	Oranje	Paars	Roze	Rood
(GB)	Black	Brown	Blue	Grey	Green	White	Yellow	Orange	Purple	Pink	Red
(ES)	Negro	Marrón	Azul	Gris	Verde	Blanco	Amarillo	Naranja	Morado	Rosa	Rojo
(IT)	Nero	Marrone	Blu	Grigio	Verde	Bianco	Giallo	Arancione	Viola	Rosa	Rosso
(SE)	Svart	Brun	Blå	Grå	Grön	Vit	Gul	Orange	Lila	Rosa	Röd
(CZ)	Černá	Hnědá	Modrá	Šedá	Zelená	Bílá	Žlutá	Oranžová	Fialová	Růžová	Červená
(DK)	Sort	Brun	Blå	Grå	Grøn	Hvid	Gul	Orange	Lilla	Pink	Rød
(FI)	Musta	Ruskea	Sininen	Harmaa	Vihreä	Valkoinen	Keltainen	Oranssi	Purppura	Vaaleanpunainen	Punainen
(GR)	Μαύρο	Καφέ	Μπλε	Γκρι	Πράσινο	Λευκό	Κίτρινο	Πορτοκαλί	Μοβ	Ροζ	Κόκκινο
(NO)	Svart	Brun	Blå	Grå	Grønn	Hvit	Gul	Oransje	Lilla	Rosa	Rød
(PL)	Czarny	Brazowy	Niebieski	Szary	Zielony	Biały	Żółty	Pomarańczowy	Purpurowy	Różowy	Czerwony